

F. A. GENRES WGBF-WEQA  
2232 E POWELL  
EVANSVILLE 14 IND  
5145

# The Broadcast Engineers' Journal

Corner of Rotunda  
at WWJ Transmitter.  
Showing the  
Transmitter

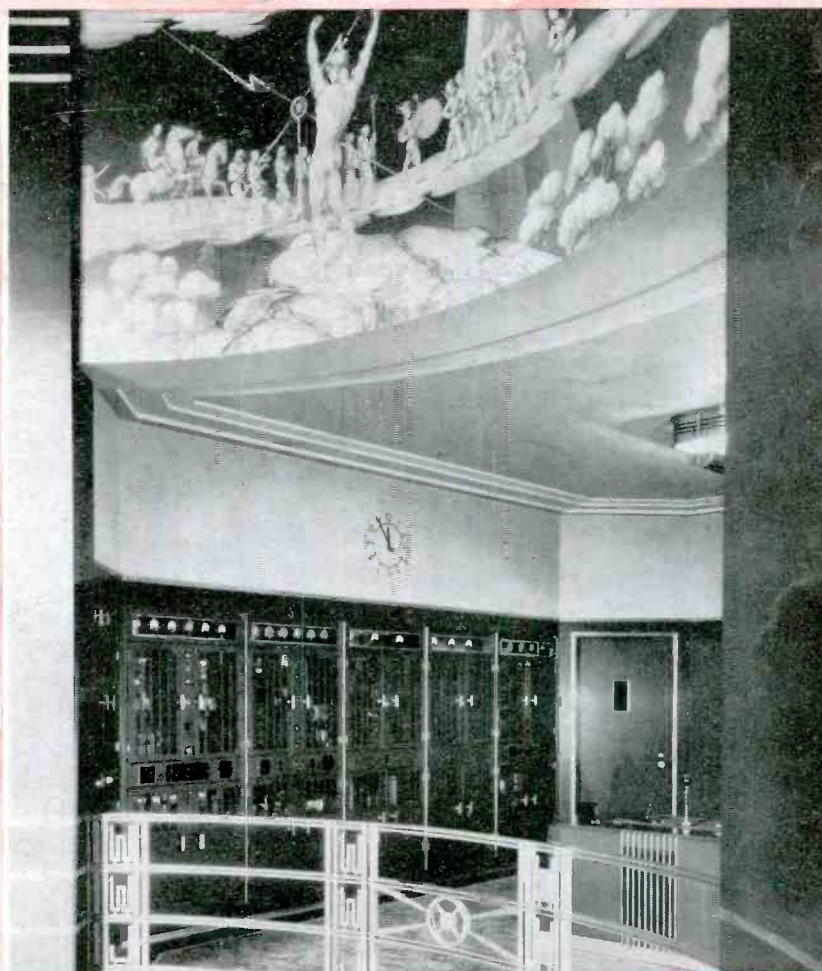

***FLASH!***

Report of  
Jan. 30  
NLRB-Petrillo  
Hearing

(See Page 17)

**FEB.  
1945**

**VOL. 12  
No. 2**

***Since  
1934...  
Of, By,  
and For***

***The Broadcast Engineer***



# GOULD-MOODY "BLACK SEAL" GLASS BASE INSTANTANEOUS RECORDING BLANKS . . .

## RECORDING AMERICA'S POWERFUL VOICE

Transmitter of America's Powerful Voice is Radio . . . awake twenty-four hours a day . . . talking to our friends and our enemies . . . transporting Broadway and Hollywood and the girl next door to the boys over there . . . building morale on the home front.

Recording America's Powerful Voice . . . in leading broadcasting stations from coast-to-coast . . . are Gould-Moody "Black Seal" Glass Base Instantaneous Recording Blanks. Made entirely of glass, "Black Seals" are as thin as aluminum, thereby eliminating the necessity of recorder adjustments. No foreign inserts . . . no metal grommets . . . no ageing, hardening or deterioration. Every disc has four holes . . . center-flow thread action . . . may be played back for months without appreciable loss of fidelity. Enclosure of your preference rating extensions with your order will expedite deliveries.

**SHARE YOUR BLOOD WITH A WOUNDED SOLDIER**  
— donate a pint to the Red Cross today

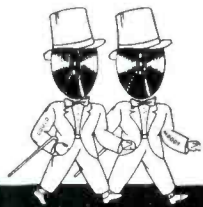

# THE GOULD-MOODY COMPANY

RECORDING BLANK DIVISION

395 BROADWAY, NEW YORK 13, N. Y.



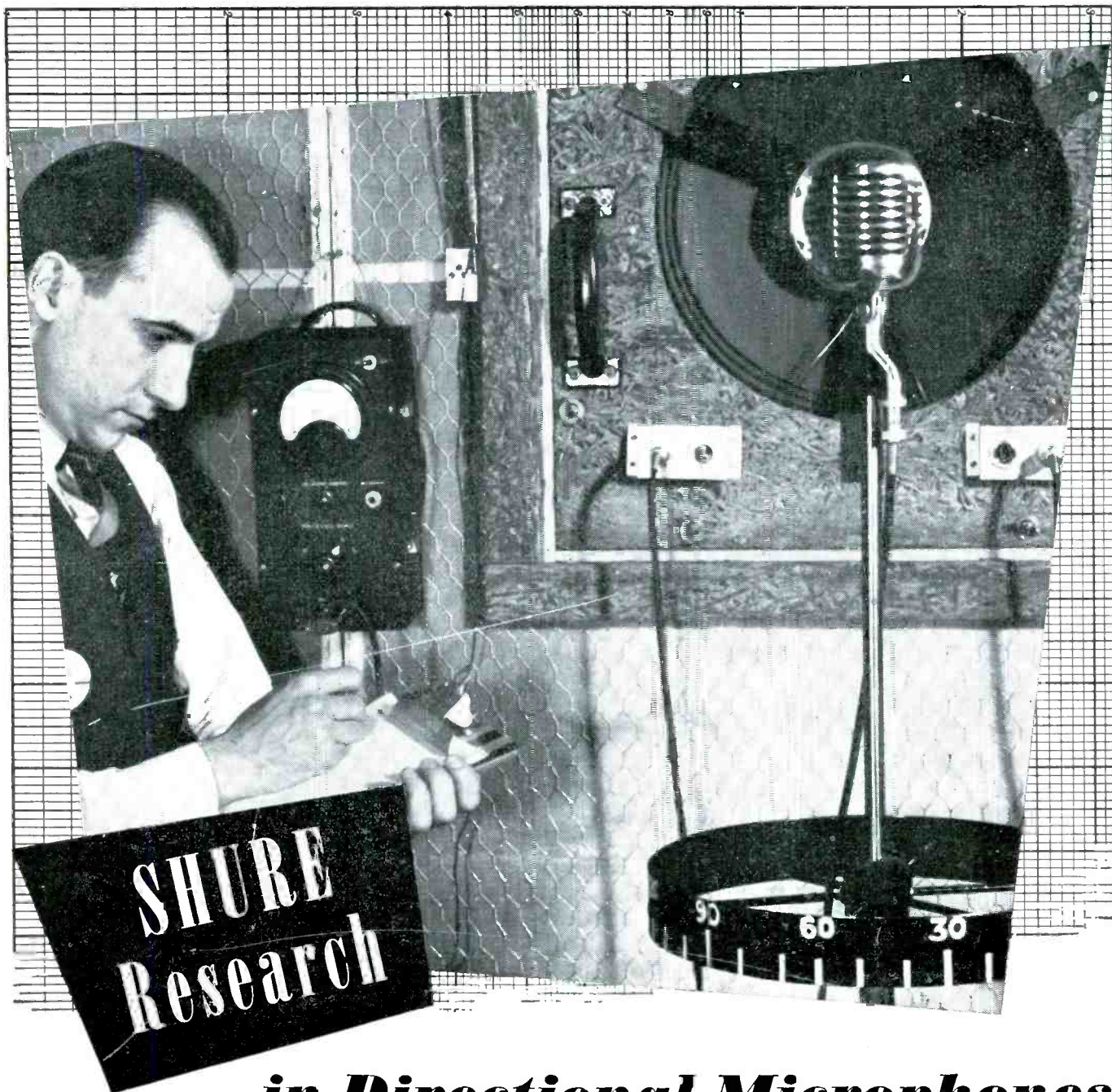

**SHURE  
Research**

## ***... in Directional Microphones***

It is not enough to design a Microphone that merely converts sound waves into electrical impulses. A Microphone, to be truly useful in modern broadcasting, should be discriminating enough to accept wanted sounds — and reject unwanted sounds. Shure Research was the first to develop a single unit uni-directional Microphone, both crystal and dynamic.

Shure Research is the reason why practically every major broadcasting station uses the Shure 556 Unidyne. Shure Research is your assurance of postwar microphone superiority.

**SHURE BROTHERS, 225 West Huron Street, Chicago**  
*Designers and Manufacturers of Microphones and Acoustic Devices*





*You'll Want this New*  
**JAMES KNIGHTS**  
 "Crystal Controlled"  
**Frequency Standard**

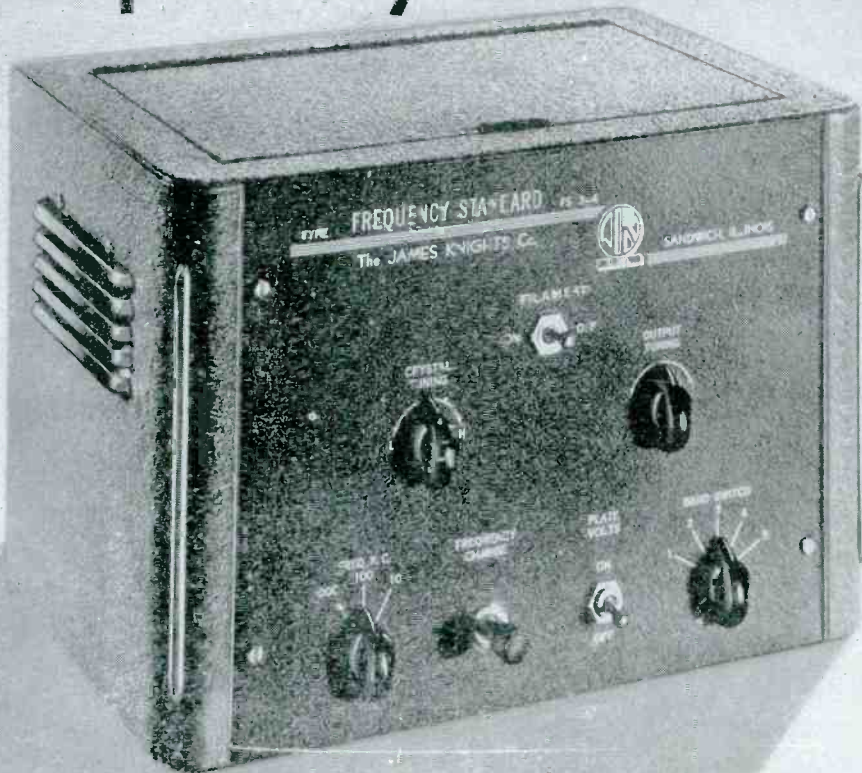

This is the ideal secondary frequency standard to check frequency of oscillators and transmitters, to calibrate and align receivers, etc. Can be used by the crystal manufacturer to check frequency standards for production. Useful many ways in the electronic laboratory or factory. Provides output up to 40 megacycles at 1,000, 100 and 10 kilocycle intervals. Complete cost only \$59.50. Descriptive catalog sheet on request.

**BUY WAR BONDS FOR VICTORY!**

**The JAMES KNIGHTS Co.**  
 SANDWICH, ILLINOIS

**CRYSTALS FOR THE CRITICAL**

# THE BROADCAST ENGINEERS' JOURNAL

Ed. Stolzenberger

Editor

Coordinator..... F. R. Rojas

Volume 12, No. 2  409 February, 1945

Contents Copyright, 1945, by A.T.E. Publications, Inc.

## TABLE OF CONTENTS Page

The Clamp Circuit—Part I.....	5
New York News, New York Blue Notes.....	10
New Television Stations.....	11
Doings in Denver.....	12
From Up the Mohawk.....	15
N. A. B. E. T. Activities.....	16
Television in Good Shape!.....	17
From San Francisco.....	20
Omaha News.....	21
Detroit News.....	24
From Rochester Chapter.....	25
From Hudson Chapter.....	25
From Hollywood.....	28
Chicago Chapter Chatter.....	32

## THE BROADCAST ENGINEERS' JOURNAL

Trustees: V. J. DUKE, H. E. HILLER, G. B. RILEY, R. A. SCHLEGEL,  
H. E. MEYER

Treasurer..... C. W. PHELAN  
Assistant Treasurer..... D. J. MOLONEY  
Staff Writers..... JORDAN McQUAY; TOM McKAY  
Contributing Photographer..... SERGEI DE SOMOV

### ASSOCIATE EDITORS

Chicago.....	A. W. HJORTH
Cleveland.....	NORMAN M. DRYSDALE
Denver.....	GEORGE POGUE
Detroit.....	DAVE STEWART
Dixie.....	REX COSTON
Engineering Chapter.....	V. J. DUKE
Hollywood.....	NORMAN DEWES
Hudson Chapter.....	RICHARD H. DAVIS
KFI-KECA.....	E. F. WILMSHURST
Mohawk.....	HORTON C. MOSHER
New York.....	G. F. ANDERSON, JR., GIL McDONALD
Rochester, N. Y.....	ARTHUR KELLY
San Francisco.....	JACK VAN WART
Washington.....	R. E. SHENTON
WLW-WSAI-WLWO.....	BOB BROCKWAY
WOW, Omaha.....	BOB RUDD

The Broadcast Engineers' Journal is a privately printed monthly publication issued by A.T.E. Publications, Inc., a corporation of the State of New Jersey. Address all communications to Editor's office: E. Stolzenberger, 116-03 91st Avenue, Richmond Hill 18, L. I., N. Y. Telephone Virginia 9-5553. **THE BROADCAST ENGINEERS' JOURNAL IS THE OFFICIAL PUBLICATION OF THE N.A.B.E.T.**

Advertising rates and information supplied on request. Subscription, \$1.50 per year; \$3.00 for three years. Single copies, except Christmas Yearbook, 25c; Christmas Yearbook free to subscribers. All remittances in advance. Foreign: Add postage.

Nothing appearing in The Broadcast Engineers' Journal shall be construed to be an expression of The Broadcast Engineers' Journal or the National Association of Broadcast Engineers and Technicians, but must be construed as an individual expression of the author or authors.

NATIONAL N.A.B.E.T. OFFICE  
930 F Street, N.W., 415 Atlantic Bldg., Washington 4, D. C.  
A. T. Powley, President



*This War . . .*

is daily emphasizing the importance of dependability and permanence in all of our equipment.

This is especially true of  
**Radio Recording  
Equipment**

*The Test of Time has proven*

**SCULLY  
Master Recorders**

to be unsurpassable as precision,  
superb recording machines

BUY U. S. WAR BONDS NOW  
and plan to install  
**SCULLY MASTER RECORDERS**  
*After the Victory!*

**SCULLY  
Machine Company**

62 Walter Street Bridgeport, Conn.

Telephone BRidgeport 4-5300



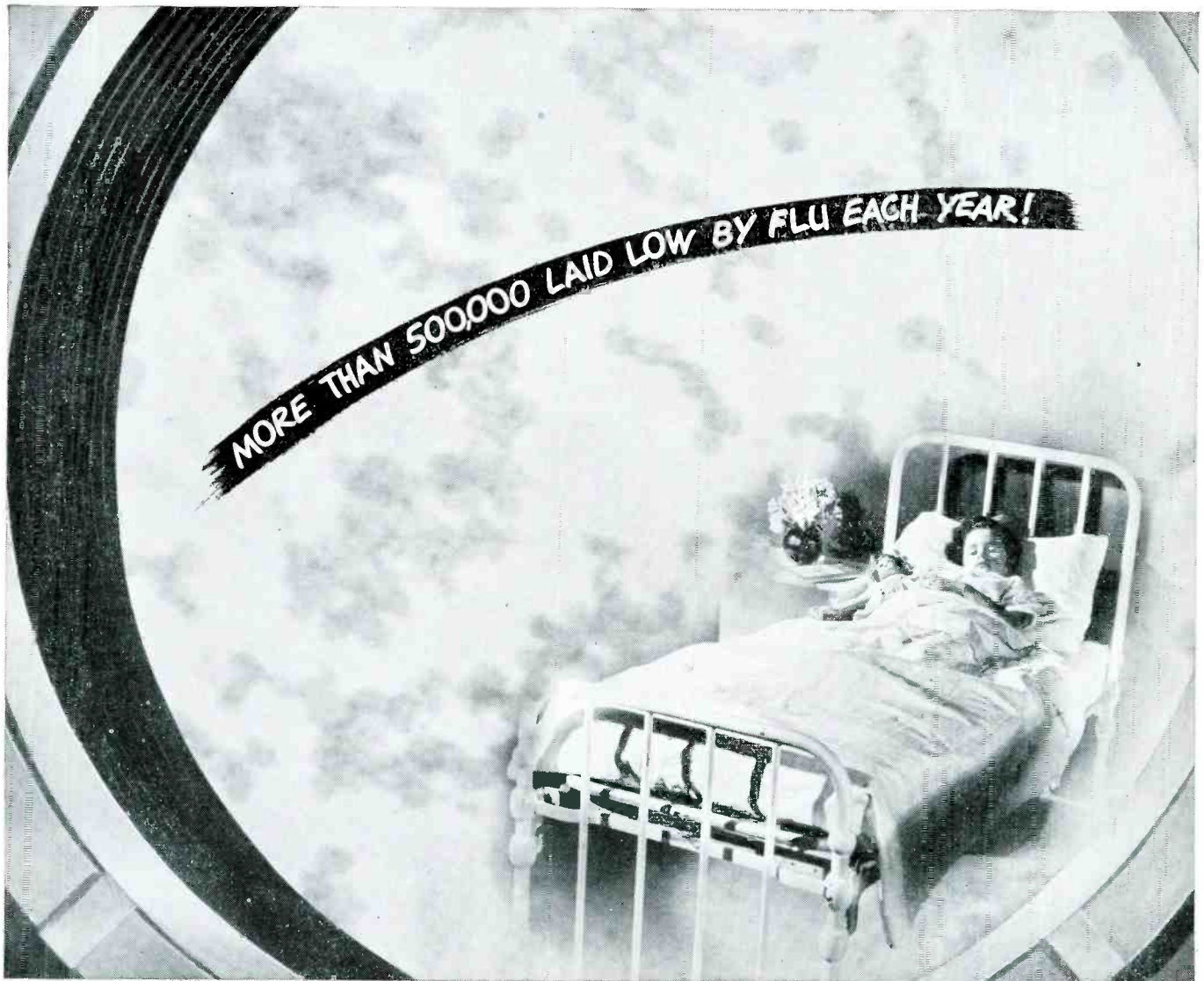

## ***to destroy 'em you have to see 'em***

Microscopes are gunsights in Medicine's battle on bacteria.

Optical microscopes, however, were not powerful enough to "draw an accurate bead" on the deadly virus that caused influenza.

But today, medical men have seen what no optical microscope could bring into focus—the infinitesimal influenza virus that previously had lain craftily camouflaged among larger cells.

This revelation came about through the Electron Microscope, developed by scientists at RCA Laboratories. And now, having been seen, influenza may be forced to unconditional surrender, saving the lives of thousands each year.

Here is but one facet of the genius shown by scientists behind RCA research . . . the

"ever-onward" research that saves lives or creates a better radio with equal skill . . . the "there-when-you-need-it" research that gave super-secret equipment to the United Nations . . . the "way-ahead" research that goes into everything made by RCA.

When you buy an RCA radio or phonograph or television set or any RCA product, you get a great satisfaction . . . enjoy a unique pride of ownership in knowing that you possess the very finest instrument of its kind that science has yet achieved.

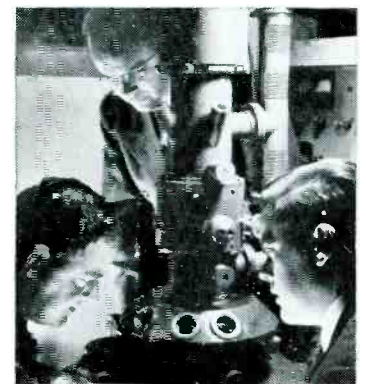

**They see what human eyes have never seen before!**

Drs. Arthur Vance and James Hillier, scientists at RCA Laboratories, with Mr. E. W. Engstrom, Research Director (standing), examine the RCA Electron Microscope that has useful magnification up to 100,000 diameters, revealing unseen new worlds to the eyes of man.

# **RADIO CORPORATION of AMERICA**

PIONEERS IN PROGRESS



# The Clamp Circuit : Part I

By C. L. Townsend

## Summary

Electrical "clamp" circuits have long been used by a relatively small group of men mainly engaged in television and radar research. This article presents an informational discussion of the capabilities of such circuits, together with enough basic design information to permit construction and operation of satisfactory equipment.

## General

FOR many years equipment intended for television use has been built including as part of the electrical design certain circuits known in the laboratories as "clamps." Several articles have been published giving precise analyses of these circuits. However, they have had somewhat limited circulation, and because of their completeness and generality of exposition were somewhat difficult to use in practical circuit construction. This article, to the contrary, will concern itself primarily with simple circuit-designers' concepts, and experimentally obtained operational information.

It would be well to note that the term "clamp circuit" as used herein refers to pulse-driven switch type circuits and specifically excludes grid-current dc restorers of usual types.

## Capabilities of the Circuit

The clamp circuits to be discussed have many properties and abilities peculiar to themselves which should be understood as being the purposes for which the circuits were developed. The following is a partial list of the functions which may be expected of them.

Reproduction of complex wave shapes requiring wide-band amplifiers is greatly complicated if that band includes very low frequencies. In such a case, critical design of low-frequency compensation circuits is required, utilizing large coupling and filter capacitors, and usually based on low power-source impedance. If the wave to be reproduced includes a certain reference point, the use of a clamp circuit will permit the complete elimination of the low-frequency portion of the pass band. The requirement that a reference be established is characteristic of the circuit. Such a reference would consist of any "flat" portion of the wave which recurs at a frequency which is high in proportion to the frequencies to

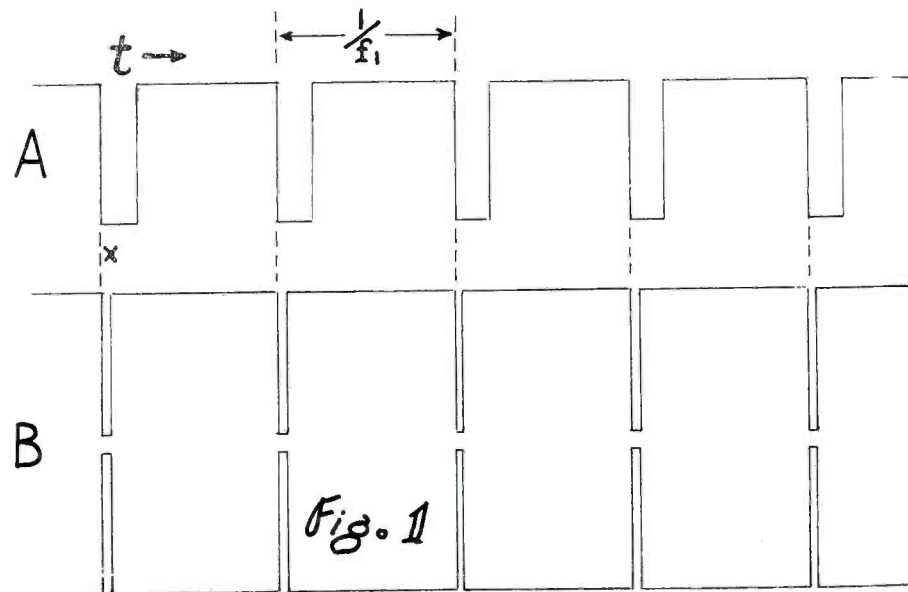

be eliminated, and which is always at the same potential when the wave is accurately reproduced. An ordinary television horizontal line voltage-shape is such a wave, since "back-porch"—that portion of blanking immediately following supersync—fulfills the requirements. Thus a video amplifier intended to pass picture voltages after blanking has been added can be designed without regard for those frequencies well below line frequency, automatically removing the listed problems.

Since the frequencies controlled by clamp action are all those reasonably below the clamp frequency, the circuit may also be used to eliminate effects of switching surges, transients due to gain control movements, power line variations, and, where long cables are concerned, ground current fluctuations. Such a circuit design often permits the production of a good wave shape under conditions of interference which would make ordinary circuits useless.

The action of the clamp circuit is to force the "reference point" to a constant potential, irrespective of interference. Consequently, a clamp may be used to place a suitable wave on some certain portion of a vacuum tube characteristic, thus controlling the operating point of the tube, making the amplification of any particular part of the wave a quantity independent of shifts in its ac axis. Supersync can be held on a fixed

point of amplification, for instance, establishing a stable black-level independent of amplifier saturation. And, since the blanking point is a definite potential, supersync may also be controlled as to amplitude independently of the picture changes. Voltages representing picture may also be processed independently of supersync on the same basis. Thus compensation for previous amplifier non-linearity and for improper sync-to-picture amplitude ratios may be effected through the aid of a clamp.

The use of a clamp as an accurate means for dc restoration in television circuits is immediately suggested by its action in holding blanking at a fixed potential. For those cases in which supersync is of varying amplitudes a clamp is far superior to ordinary grid-current, or diode current type dc inserters.

## Circuit Development

Understanding of the basis upon which a circuit capable of producing the above results may be built is facilitated by reference to the diagrams of Figure (1). At (A) a simple wave of the type which can be treated successfully with clamp action is shown. It consists of a rectangular wave, drawn for convenience with a short-duration negative stroke. As generated, this wave contains no frequencies below  $f_1$ . In Figure (2-A) the same wave is shown with an interfering low-frequency,  $f_2$ , added. It



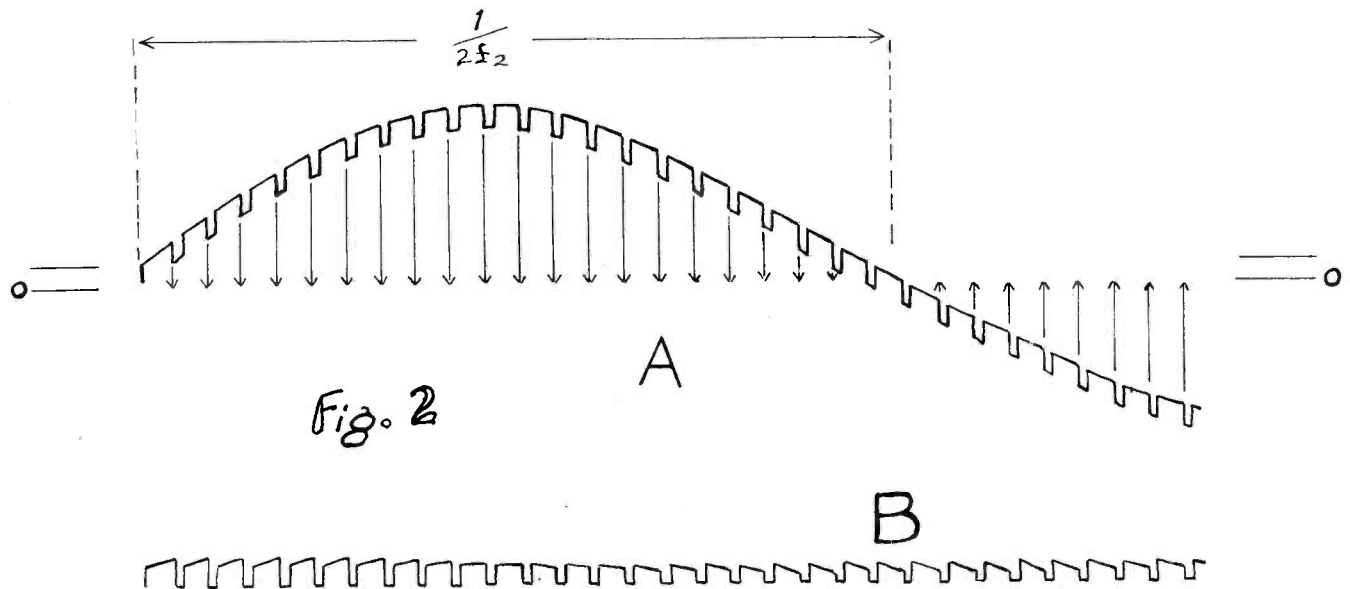

Fig. 2

is the purpose of the clamp to remove  $f_2$ . If the beginning of each cycle of  $f_1$  (marked with an "x" in Fig 1 "A," in this instance) could be brought to a constant voltage, action such as that indicated by the arrows in Figure (2-A) would take place. As  $f_2$  crosses its axis

in a positive direction, the clamp action forces the "x" points of the wave down to the zero potential line. When the voltage of  $f_2$  swings negative, the clamp action forces all of the "x" points up to zero potential. Consequently, as shown in Figure (2-B), all that remains of  $f_2$  is that portion of its voltage change which occurs within the cycle of  $f_1$ . With  $f_1$  very high in proportion to  $f_2$ , this residual effect is vanishingly small, and usually can be neglected.

charge period which is the reference point previously mentioned as being required in a wave to be clamped.

Since the operation of (S) in Figure (3-A) must occur at high frequencies, the use of a pair of diodes suggests itself immediately. The circuit of Figures (3-B) indicates the basic principle of diode switch operation. When the double-pole-double-throw switch is in the left-hand position, both diodes are biased open, and the RC time constant is unaffected by the presence of the diodes. When the switch is in the right-hand position, both diodes are conducting, and a low impedance path is provided from C to ground. If the charge on C has produced a positive potential to ground across R, the right-hand diode provides the path to ground, and if the signal potential is of the opposite sign, the left-hand diode provides the discharge path. Also, since the battery merely supplies polarizing voltage, it and the switch can be replaced by voltage pulses from an amplifier, provided that the pulses have the same polarity and duration of voltage as was previously obtained from the battery-switch combination.

The above reasoning results in the circuit of Figure (4). It is assumed that the input pulse (P) is timed as shown in A and B of Figure (1). All circuit elements can be used at high frequencies, and excessive shunt capacitance on the signal circuit is avoided. Such an instrument is therefore practical, and subsequent design modification will be in the nature of refinements rather than basic changes.

Consider the action of the circuit of Figure (4). When a positive pulse of

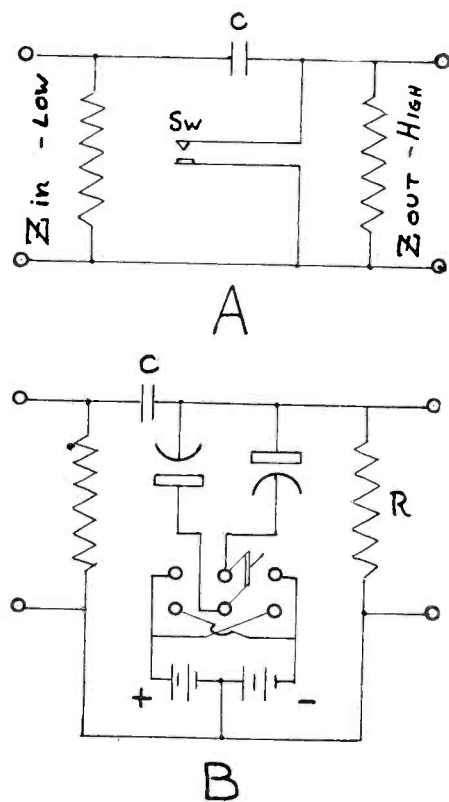

Fig. 3

Consider the generic circuit shown at Figure (3-A). Across the input terminals the wave-shape of Figure (1-A) is impressed, and across the output terminals the wave is reproduced faithfully when the time-constant of R and C is long in proportion to the time of one cycle of  $f_1$ . If the wave of Figure (2-A) is impressed across the input terminals, it is likely that with RC long, some of  $f_2$  will appear in the output. However, if the switch (S) is closed at the instant (x) in each cycle of  $f_1$  only long enough to discharge (C) through (Z-in), and then opened again, it can be seen that the flat portion of the wave following (X) will always be at ground potential. Following the opening of switch (S), the voltage changes applied to C will be reproduced across R. These are represented by the step rise in positive direction, the long horizontal positive period, and the return negatively to point (X). The charge representing the wave  $f_2$  has been removed from (C) at point (X) by short-circuiting it through the switch. However, the  $f_1$  wave-form requires no charge on C during that period and is consequently unaffected by the switch action. It is this zero-



short duration is applied to the triode grid, a similar pulse of smaller amplitude is generated across RLK. Another pulse, identical except for reversed polarity, is produced in the plate circuit when RLP is of the correct value. These two pulses form the waves of Figure (1-B). The pulses are coupled into the diodes through blocking condensers, the diodes themselves being shunted by  $R_1$  and  $R_2$ , charging the blocking condensers in such a way as to reduce the diode current. Thus the  $D_1$  blocking condenser shows a positive dc voltage on the diode side, and the  $D_2$  blocking condenser shows a negative dc potential, with respect to ground. The pulse current, therefore, is only sufficient to supply the losses which have occurred in  $R_1$  and  $R_2$  during the cycle. This action is precisely similar to that occurring in the grid circuit of a vacuum tube which is self-biased.

Figure (5) is a diagrammatic representation of the clamp potentials. Diode current flows only when the pulse voltage exceeds the bias voltage. This portion of the cycle is shown as the shaded area of Figure (5). During the remainder of the cycle both diodes are non-conducting. The required switch action has therefore been obtained, since the diodes conduct precisely as in Figure (3-B).

The operation of the clamp of Figure (4) is the same as the generic types. If during the clamp period there is a charge on C, it is removed through the diodes. If the charge produces a positive potential at the output,  $D_1$  provides the discharge path, through its blocking condenser and the RLP and VT combination to ground. If the charge is of opposite sign,  $D_2$  provides the path through its blocking condenser, and the RLK and VT combination. Both of these paths are of low impedance as required for rapid discharge of C.

It was previously stated that the use of a clamp circuit such as has been developed should permit the elimination of the very low frequencies usually present in a television picture signal.

As an illustration of this action, consider the diagrams of Figure (6). At (A) a wave is represented which it is desired to reproduce. This wave has no reference point, since no part of it returns to a constant potential at a frequency high in proportion to the low frequencies of the wave. At (B), however, high-frequency pulses have been added to the wave of (A), and these pulses have been adjusted in length so that their negative tips are always at the same potential, regardless of the ampli-

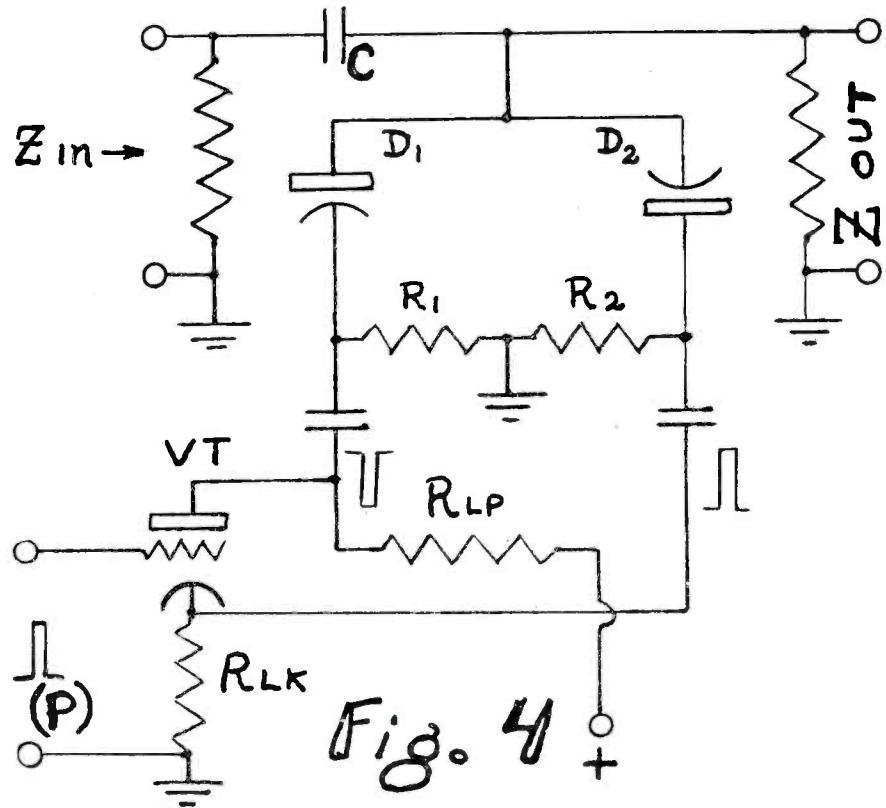

Fig. 4

tude of the (A) wave. This potential is represented by the line (X-X). These pulses do not destroy the basic shape of the wave to be reproduced, and are so timed as to avoid interfering with its usefulness. Now if the low-frequencies are eliminated from the wave of (B), the wave of (C) results. The long hori-

zontal portions of the (A) wave have been lost, but the amplitudes of the reference pulses have not been changed. Therefore, if clamp action is applied to the (C) wave at the most negative point of each reference pulse, all these pulse tips will again be forced to a constant potential, and the wave of (B), com-

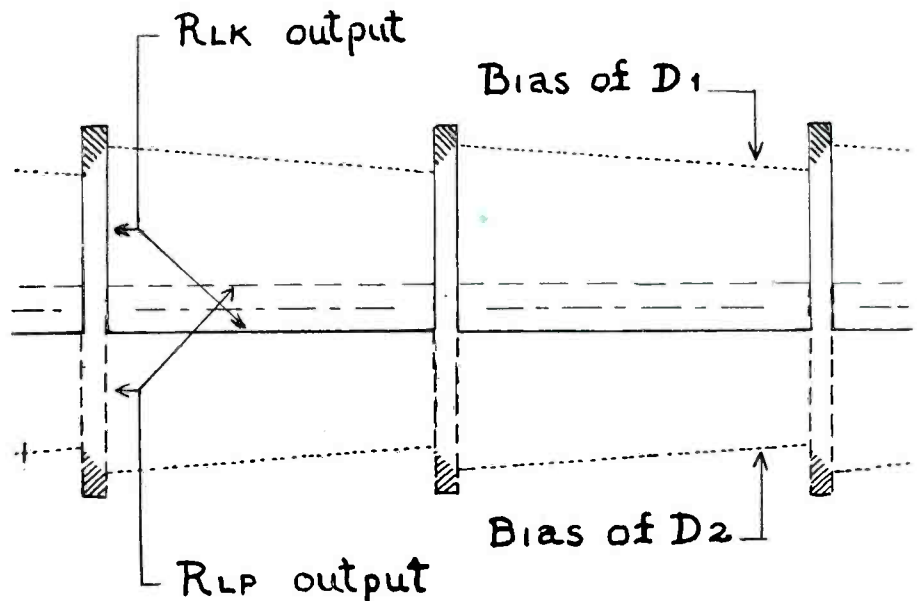
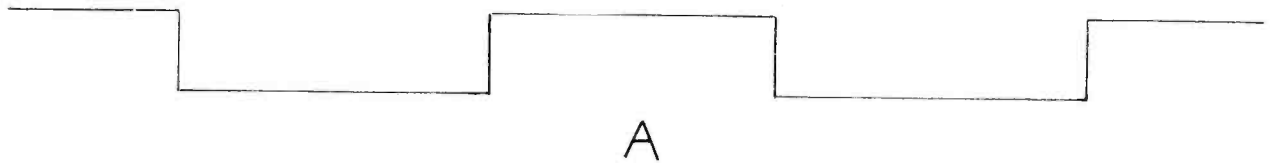
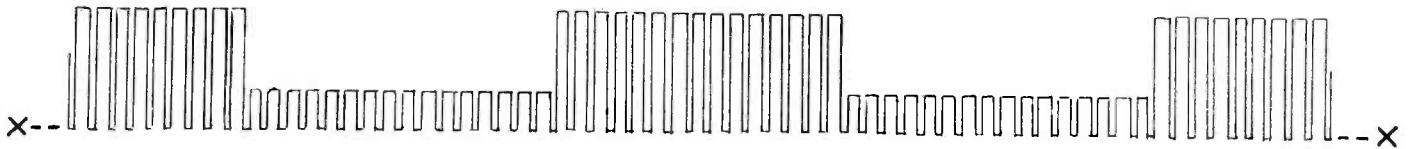

Fig. 5



A



B

Fig. 6

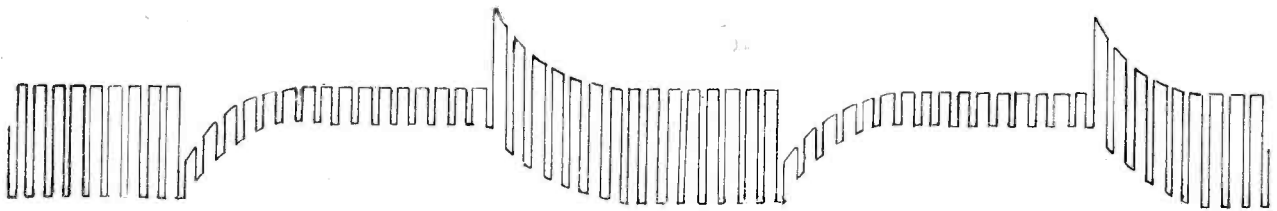

C

plete with its original low-frequencies will again be produced.

Consider a television system operating at sixty fields and 525 lines per second. The low frequencies in question are those from 60 cps to approximately 1,000 cps. These frequencies provide information as to the average brightness of one line with respect to others, and define the slope and amplitude of vertical pedestal. In the early video amplification following the pick-up tube these frequencies are usually carefully preserved until blanking is added. Blanking is then "clipped" at a constant "black-than-black" potential. Since this level is constant, all brightness changes in the picture, whether line-to-line, or frame to frame, are produced by voltage changes with respect to the blanking level. It is, therefore, only necessary to clamp all horizontal blanking periods to the same potential to produce an accurate reproduction of the original picture. If the video amplifier used includes a coupling circuit such as that of Figure (4), the value of (C) may be made very small, and other stages of amplification preceding may be treated in the same manner, completely eliminating the normal-wave field structure, yet retaining all necessary information. Such a

wave, properly clamped, will regain its vertical pedestal and blanking voltages in their original amplitudes. If the clamp circuit starts each line at the proper brightness, then the frame will also be at proper brightness, for variations in average brightness can only occur within the time of a line, and will be corrected at the beginning of the following line. Since both vertical and horizontal blanking were originally held at a fixed potential, clamping them to a fixed potential after variations have occurred will restore them to the original conditions.

**Part II, Circuit Design,** will appear in our March, 1945, issue.—Ed. S.

A new and advanced RCA Audio Chanalyst, which provides complete sound system testing equipment in a single unit, has been announced by RCA Victor. The new Audio Chanalyst, RCA Type 170A, is comprised of several self-contained testing sections or "channels" and can be used to test any point of any sound system from microphone to speaker, serving in emergencies as a bridging unit to substitute for the defective section of an inoperative amplifier. The Audio Chanalyst contains a calibrated high gain amplifier useful for signal tracing,

tube checking and gain measurements. It supplies its own test signal from a built-in Beat Frequency Oscillator, which can be operated by an internal auxiliary sweep circuit for checking multiple speaker installations. The famous Volt Ohmyst is included as one of the channels and it has been modified for flat, linear measurement of audio frequencies. An impedance tester and a high-speed Electronic Indicator add to the unique testing facilities of the Audio Chanalyst, as various combinations of its channels can be used for audible and visual testing.

The Universal Microphone Co., Inglewood, Cal., this month (February) completes its series of history of communications full page advertisements it has been carrying in the trade press the past 15 months and will immediately launch a new series. The new copy will open with an announcement of the D-20, first new Universal product for the civilian market since Pearl Harbor. It will be followed at intervals of 30 days with photographs and complete technical description of the new dynamic microphone for broadcast use.



# Faithful Reproductions?

## Well....

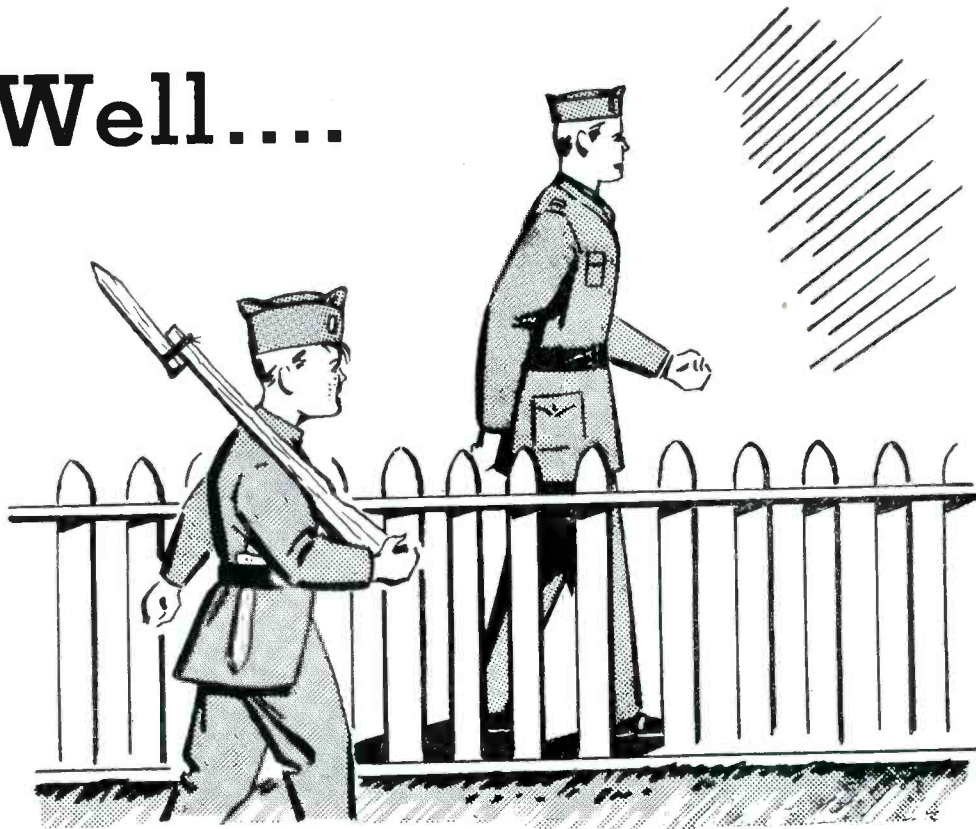

It isn't a matter of great urgency if little Oliver's khaki suit doesn't fit with the same precision as his hero's. No one will care if he falls asleep while guarding his miniature military installation . . . or if he pretends his crackers and jam are K-rations. We even venture to say his wooden gun will be just as effective against imaginary enemies as any automatic rifle ever could be. This is one case where faithful reproduction need not be emphasized too much.

But when a man's bread and butter depends upon faithful reproduction, that's

another story—one that an engineer in any recording studio can tell, for it is his job to see that all recorded reproductions are faithful. He can tell you how it's done, too—by using **Advance Recording Blanks**. With Advance Blanks, maximum fidelity is always guaranteed. They can record an amazingly wide range of tones—ranging from upper treble to lower bass—clearly and naturally. And they have all of the other requirements of a long-lasting, quality product. To obtain really superlative results, send for **Advance Recording Blanks now**.

When you invest in War Bonds, your original investment is faithfully reproduced in ten years—plus an extra dollar for each put in.

**Advance**  
Recording Products  
Company

36-12 34th STREET • STILLWELL 4-7837 • LONG ISLAND CITY, N.Y.



—Photo by Joe Conn

## NEW YORK NEWS

By George F. Anderson, Jr.

**T**HOUGH this bit of chitchat will appear in the second issue of the Journal in the New Year, 1945, it is the first one to be written by your editor in this, a most promising year.

In the news and cards that were received here in New York during the holidays were some from every part of the globe, it seemed. Lieut. Commander Donald Ewart, USNR, sent Christmas and New Year's greetings from London, England. Captain Victor Tervola, AUS, sent a comic "V" mail card from Italy, showing Vic trimming a Christmas tree with spaghetti. And bringing his greetings in person was that famous exponent of South American amor, Lt. Fernando Montilla, USNR. Lieut. Montilla has been in Brazil for over a year and came back to the States for a



holiday visit and to check up on how things were progressing here in New York.

From the opposite side of the world we find that Captain Dixon, AUS, has been sent back from the outposts of the

(Continued on Page Eleven)

## NEW YORK BLUENOTES

By Gil McDonald

**M**AURICE KAMKE sends in a lot of dope this month about the transmitter boys out in Fog Holler.

**Fred Parry**, the youngest and smallest member of the WJZ transmitter staff, has just resigned for an OWI job in the South Pacific. His place is taken by **M. L. Spinelli**, who was summer relief man.

**Ted Cain** is still having his headaches trying to combine Parry's Lafayette Television chassis with his own Dumont Television receiver. The whole living room is deep in haywire but, says Ted, "Anything for science".

**Byers** is quiet these days.

**Bill Mullaney** feels robbed these days since his other source of income stopped running.

**Al (Tiny) Sturhann**, after breaking all the chairs in the place, just finished a foreign make radio that needed repairs (on his own time, of course). Al and the Mrs. became the parents of a five pound fourteen ounce son on December 3. This is their first child. Mother and child are fine.

**Henry Treger** (Asst. Chief) still manages to find lots of work for the boys although they have re-painted, repaired and re-juvenated just about the whole place.

**Willie Storrs** still leaves the place with his usual, "Well, so long, boys, no runs, no hits, no errors," and back to his chateau in the Plainfield hills.

**Mece Kamke** is all tied up in a real estate deal involving a mud lake which the "Squire of Rhubarb Patch" claims has post-war possibilities.

**Nick Hagman**, the head swami out there, is fooling around with Hi Freq stuff besides trying to get the dark room set up.

That's all from the WJZ gang except that **Alphonse**, the janitor, is quite proud of all the vegetables he canned from his victory garden.

**Deric Leighton** gave up studio engineering for a job in Blue Production. Lotsa luck, OM!

(Continued on Page Eleven)



## NEW YORK

(Continued from  
Page Ten)

world to a more civilized section to indulge in some red meat and fresh vegetables.

Between Christmas and New Year's among other visitors were two more Navy officers, W/O Herbert Florance and Lieut. (jg) Harry Grelck.

In this column is a photo of a bit of test equipment, constructed by Field Engineer James Hackett. The use to which this bit of construction was supposed to be put to, was to check the operation of an NBC-ND 10 Field Amplifier. James complained that there were too many Gremlins present in it whenever he attempted to use it. However, up to the present time, no one has been able to see any Gremlins attached to it. A photo was taken to see if the film could or would show any Gremlins, but as you can see from the photo, there are none in sight.

Since the formation of the "Sealed Door Club," there have been no new members applying for entrance, in fact, one of its members has transferred from Maintenance to Studio. The transferee into that exclusive and hard working clique is none other than Harold Luedeke.

Because of the poor attendance at the meetings held for the above mentioned club, it was decided to abandon it and start another to be called "The Broken Bottle" or "Don't try to lick it up, fellows, you might get glass slivers in your tongue," Club. Again there are only two members of this club, senior member and first vice-president is Mel Lewis, well known and loved member of the Maintenance Department, and junior member and second vice-president is Charles "Chuck" Beardsley, Recording Engineer—par excellence.

The burial of the first glass container was very suitably handled by the Maintenance Department. The remains were placed in a black velvet-lined, shoebox, a cross erected and candles lit. The second container was swept up and put in a trash basket. Mel merely dropped the bottle on the floor while demonstrating to someone that the contents gurgled. Chuck used a more subtle manner to dispose of his, rather our, bottle—he placed it in a cabinet and shut the door. The only thing wrong with this was the fact that when he let go of the bottle, it was still a foot from the cabinet.

Membership in this exclusive club is not limited.

The back-to-work movement sees Paul Herold, Senior Master Control Supervisor, and Dorson Ullman, Studio Engineer, back at their respective positions.

Many thanks are extended to John Norton, Studio Engineer for the Blue Network, who designed the NABET New York Chapter page in the Year Book Issue of the Journal.

December 14th, the Recording Department was treated to a birthday cake. 'Twas Louise Fogarty's birthday and Ruth Reddy, apprentice, stayed up till 4 A. M. the previous nite, baked a delicious cake and presented it to Louise. The cake was nicely decorated and had an "X" number of candles on it. We haven't been told exactly how many candles there were on it, but we understand that there were not very many.

Another visitor last month was Richard Lane, Loyal Lane's son. Richard is a handsome young Marine, and looking at him one can see how Loyal looked when he was a young man. Loyal remarked that while he left school in 1917 to join the Army, and returned from France with eight years of schooling to be completed, Dick has done much better so far.

Richard received his high school diploma from Bayside

at the age of seventeen, entered Rollins College, in Florida, immediately, and finished two and a quarter years of college study before he entered the Marines at the age of eighteen. The elapsed time between high school and the Marines was only twelve months.

Richard is in Combat Intelligence, has completed boot training and has received the sharpshooter, bayonet and grenade medals and now is studying the Japanese language in preparation for some first-class intelligence work in the near future.

We would like to add that Dick is probably the only serviceman with both parents NABET members.

And now, as a final item, we note that Frank Barron, from San Francisco, is here in New York, where he is a studio engineer. Frank left his family in California because he says that he has no desire to make icicles of them. Gosh, it's not cold here. Hey, who has a blow torch—I want to thaw my ears.

Bye now. . . .

## NEW YORK BLUE

(Continued from  
Page Ten)

Bob Leslie Dougherty (the smiling Irishman) is a sad, sad man these days. After buying a purty new white Palm Beach suit, and hiring a first class cabana, getting tickets for that Florida job, and feeling pretty gay about the whole thing, came to work the other day to find the whole deal cancelled. Cheer up, OB, there is always Roseland.

Welcome this month to Seymour Paget, a new studio engineer just released from the Army. He worked for several small stations in the South before being inducted.

That's it for this month, fellows. 73.

## New Television Stations

### From FCC Report No. 1692

Television Productions, Inc. Relay broadcast stations at Peru Mountain, Vt.; New York, N. Y.; Buffalo, N. Y.; Detroit, Mich.; channels 13 and 14, 230-242 mc, and channels 15 and 16, 258-270 mc. Relay broadcast stations at El Paso, Texas; Des Moines, Iowa; Chicago, Ill.; Los Angeles, Calif.; channels 9 and 10, 180-192 mc, and channels 11 and 12, 204-216 mc.

### From FCC Report No. 1695

Star-Times Publishing Co., St. Louis, Mo. Channel 2, 60-66 mc.

### From FCC Report No. 1697

Maryland Broadcasting Co., Baltimore. Channel 3, 66-72 mc.

### From FCC Report No. 1700

Capitol Broadcasting Corp., Indianapolis. Channel 3, 66-72 mc.

### From FCC Report No. 1702

World Publishing Co., Omaha, Neb. Channel 7, 102-108 mc.

### From FCC Report No. 1706

WDEL, Inc., Wilmington, Del. Channel 1, 50-56 mc.  
Crosley Corp., Columbus, Ohio. Channel 2, 60-66 mc.

### From FCC Report No. 1710

WLIB, Inc., New York. Channel 17, 282-288 mc.

# Doings in DENVER

By George Pogue

AS WE welcome the year 1945, there passes in review the events of the old year, the most recent of which were New Years Eve, Christmas, and KOA's 20th Anniversary celebration. Nearly everyone got by all three OK with very few casualties. On New Year's Eve, the editor's report roundup gave **Walter Morrissey** and your reporter a pre celebration slight headache when Kansas City failed to give the cue for Denver. After much fumbling around and after what seemed eons of time, we got GA from Chi and as usual the program progressed merrily on its way.

**Milt Hall** had the studio gang out to his home for a gala New Year's Eve party. This has become one of the traditions at KOA, it seems. The party started early and ended in the wee small hours. This plan worked out fine for both the night crew and the morning crew, as all could come early and stay late or come late and stay early. There was the usual flipping of coins around the place to see who would work when.

KOA had its annual Christmas party at the studio once more. The refreshments flowed plentifully and the entertainment was of the merriest. Presents were handed out to all the gang by Santa Claus who turned out to be **Clarence Moore**, our program director. There was only one drawback; we missed **Vern Andrews** as leader of the mistletoe parade—too bad he and **Aubrey Blake** had to be absent installing field equipment in the churches for our Christmas Eve pick-ups.

As part of the 20th Anniversary celebration at KOA, the engineers who have been with KOA these twenty years put on a half-hour show over the air. They related some of the experiences they had had putting on studio and field shows way back when. Some of the stories told of the real headaches of those who pioneered in radio, but all were stories of real triumphs over what sometimes seemed insurmountable obstacles, and viewed through the slight haze of time were quite humorous. Those taking part

were **Bob Owen**, engineer in charge; **C. A. Peregrine** and **Walter Morrissey**, studio supervisors, and **Francis Nelson**, transmitter engineer. The rehearsal had the usual doubtful note, but on the air at long last, they came through like veteran mike men—and most of it was pretty swell ad lib too. The photographs show how they looked before and after the broadcast. Even **J. A. Slusser** took on an aged look.

From our engineers in service, all of whom are in the navy, we relay Christmas greetings even though belatedly. There was a nice Christmas card from **Lt. Comm. J. A. Slusser**, **Al McClellan** has been promoted from Warrant Officer to Chief Warrant Officer, and **Glen Glasscock** has gone back to the coast and from there we know not where.

To those who are worried about what **Douglas "Pinkie" Kahle** came back with in the Denver Doings in the November issue of the Journal, we will say that it wasn't—"ragtime piano playing including trick endings." In case of further interest, we refer you to page 31 of the same issue to clear things up.

Studio vacations have finally come to an end so that **Garland Dutton** has returned to the transmitter and **Oliver Pierce** who was relief man at the transmitter has left. **Joe Finch** was the last to come back from his vacation; he is all full of vim and vinegar and is figuring out how we can use the "gongs" and chimes so that we can see them when television comes to Denver.

We missed the cheerful face of **Joe Rohrer** around MCR during the holiday season. Joe came down with lobar pneumonia just three days before Christmas and was in the hospital for over two weeks. That's no way for a guy to spend his holidays, but happily we can report that he is well again and back on the job. One of our announcers wants to know whether you get lobar pneumonia hanging around midget beer joints . . . PHE-EW! . . . with that it seems that it is time to wind up for now. C. U. next month.



Here are the four men that "went on the air." Standing are **Bob Owen**, Engineer in charge, and **C. A. "Perry" Peregrine**, Studio supervisor. Sitting, are **Walter Morrissey**, studio supervisor and **Francis Nelson**, transmitter engineer. The picture that Perry is holding is **Lt. Comm. J. A. Slusser**, Chief transmitter engineer. The other picture is the same group after their Program "100 Years of Broadcasting."



# how high is very high?

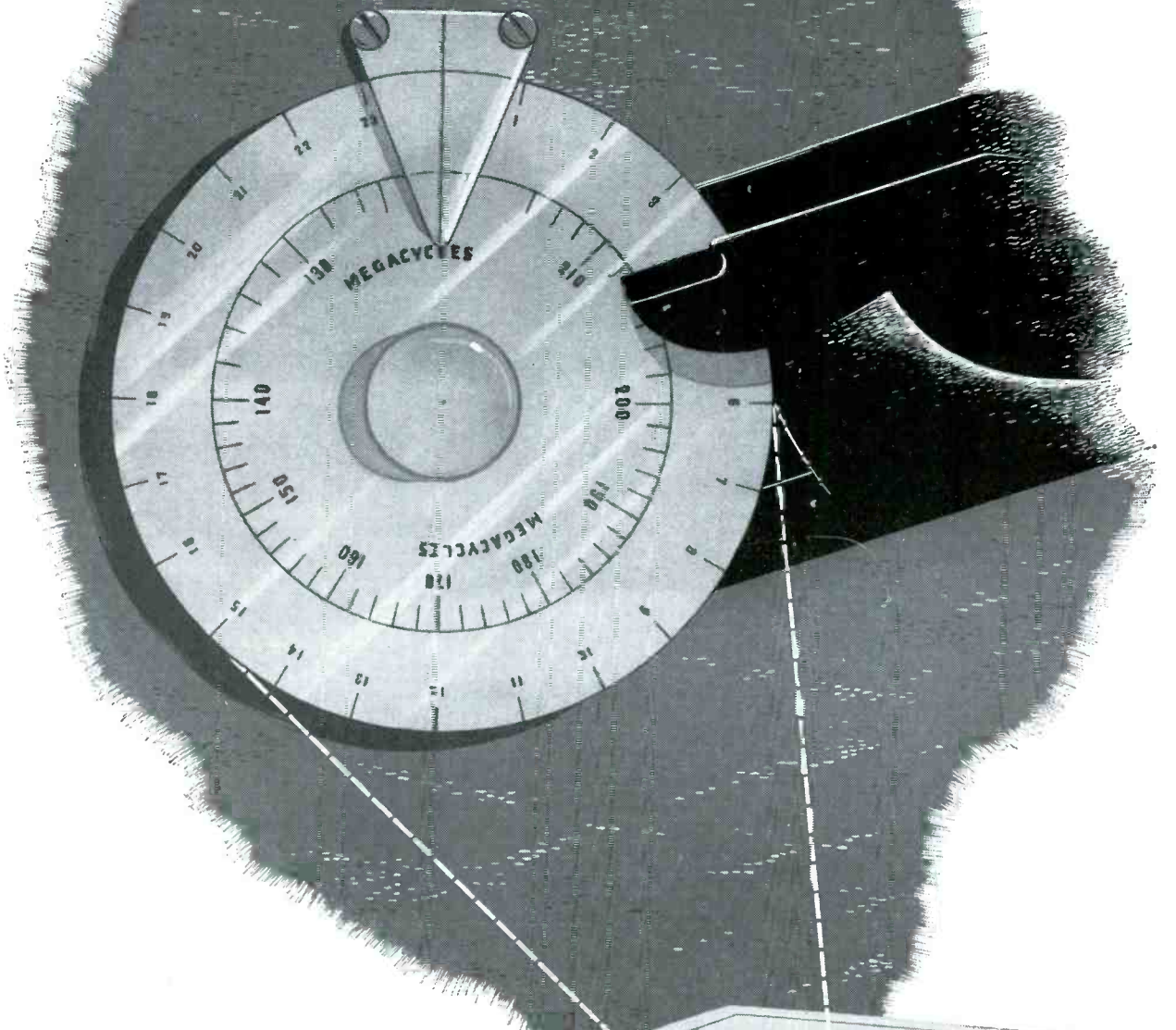

★ Engineers at Hallicrafters are continually striving for new heights of perfection in high frequency development work. The Model S-37 is one example of the progress they have made. This is the first and only set of its kind — covering both AM and FM and operating in the range of 130 to 210 Mc. Two r.f. stages are used and in conjunction with an intermediate frequency of 18 Mc., assure an amazingly high ratio of image rejection. It is becoming a valuable instrument in the hands of all exploring the upper reaches of the high frequency ranges.



*Model S-37. The highest frequency range of any continuous tuning commercial type receiver.*

**hallicrafters** RADIO



Buy a War Bond Today!

THE HALLICTRAFTERS CO., MANUFACTURERS OF RADIO AND ELECTRONIC EQUIPMENT, CHICAGO 16, U. S. A.





# Jam Sessions that DIDN'T

**F**ROM Goebbels' point of view, it was a good idea. At his direction, the Nazis attempted to fill Allied wavelengths with howls and screeches, jumbled talk, crashing music . . . *anything* to prevent the NBC Allied news in French, Italian, Swedish, Danish, English and German from reaching the continent . . . *anything* to jam our overseas broadcasts into gibberish.

But it didn't work. For when German interference starts, the OWI—informed from points overseas—advises NBC. Newsrooms of the International Division are equipped with a signal system which enables commentators to outwit Axis jammers by a quick change of pace.

The instant jamming begins, a sign reading "Speed Normal" is changed to "Speed Anti-

Jam." Commentators and newscasters slow down from 120 to 68 words a minute, articulate more deliberately, even spell out difficult words to make certain they are clear.

Result: the truth continues to get through to the Continent despite the enemy's frantic efforts to prevent it.

This simple example of how the National Broadcasting Company, in co-operation with our war agencies, is helping to defeat the Axis in the battle of words is representative of the similar painstaking attention to detail found throughout every NBC department and division.

Unceasing efforts to achieve pin-point perfection—to leave no detail neglected—to achieve the highest possible degree of service—help make NBC "*the Network: Most People Listen to Most.*"

## National Broadcasting Company

America's No. 1 Network



A Service of Radio Corporation of America



# FROM UP THE MOHAWK

By Horton C. Mosher

**T**HE Mohawk Chapter held its first Christmas party at the Canterbury House, on the banks of the Mohawk, just outside Scotia. Where is Scotia? Why, that's the beautiful village Schenectady is just across the river from!

All members who were not working gathered, bringing their wives, husbands, or sweethearts if available. We were glad to have with us some of the executives and their wives—the Purcells, the Crugers, the Knapps, and the Milhams.

## PHOTOS (Top to Bottom)

Mohawk Chapter 1944 Christmas Party.

Early in the evening. L. to R., Al Knapp (CS), Mrs. Knapp, Mrs. Cruger, Bernard Cruger (Ass't Eng.), Mrs. Mosher, Mrs. Shay, Jack Shay, Fran Ahearn, Roy Stiberg.

Chairman Don Morey and Mrs. Morey, Mrs. Bergman and our Sec.-Treas., Hal Bergman.

Pappy and His Harem! L. to R., Ruth Wallgren, Ray Forester, Maude Ellison, Al Knapp ("Pappy"), Fran Ahearn, "Perky" Blizzard, Debby Cotton and Dotty Martin. Charlotte Frey, Connie Snyder and Jane Clark were absent.

Pres. Powley spent his Thanksgiving vacation helping the Mohawk Council. L. to R., Paul Adanti, Ken. Durkee, Don Morey, Mr. Powley and Hort Mosher pinch-hitting for Ray Strong.

We missed Harold and Mrs. Towlson, absent because of illness in the family. Cruger, Knapp, and Towlson were all charter members of ATE and no party could be complete without them.

It was startling for some of us to realize we had not seen each other for years, although we had talked together by 'phone almost daily. Many of the transmitter men had never met some of the girl ops from the studios. Needless to say, it didn't take long for them to make up for lost time and the party got under way. So, with chinning and wining, and dancing and dining, everybody really got acquainted at last. After the midnight supper, Don Morey, our chairman, extended the greetings of the season to our guests and thanked the gals responsible for the party,—Fran Ahearn, Maude Ellison, and Dotty Martin. Then Ruth Wallgren—no mean pianist—took her place at the piano and Dotty Martin led the gang in singing.

Two A. M. came all too soon for some of us older guys. To this day we have been unable to find out just what time the younger set did stop dancing! Anyway, a good time was had by all. Everyone wants to get together again, and soon.

Jim and Mrs. Closson are the proud parents of another lovely daughter, their third. Ruth Mary arrived Christmas night. Old Saint Nick surely had a prize package in his sack that day and the Clossons are to be congratulated on getting such a fine present. . . .

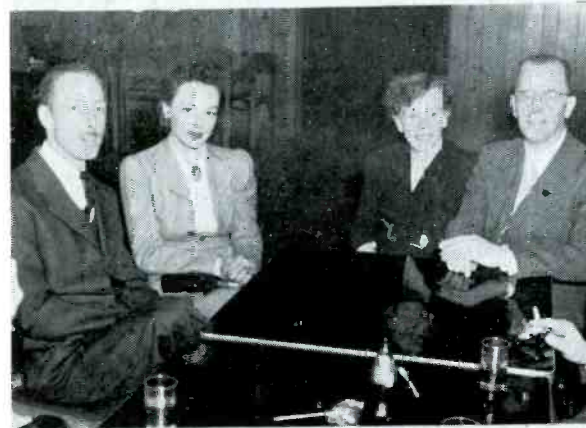
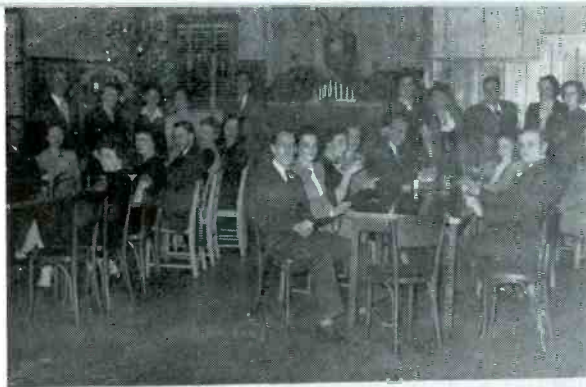

# Summary of N. A. B. E. T. Activities

## NABET VICTORY SLOGAN: Burst the Petrillo Hot-Air Balloon !

**U**NDER date of Dec. 7, 1944, NABET President Al Powley issued a news release relative to the Petrillo-Jack Benny fiasco. It seems that Petrillo thought he could demonstrate HIS "power" by repeatedly threatening the removal of HIS musicians at the last minute, and without warning or notice. All hot-air balloons have a natural ceiling which is reached when the addition of just a bit more hot air causes the balloon to exceed its elastic limit. Certainly the broadcast industry is bigger than any one man. The industry has been hurt and degraded in the public's eye, and especially in political Washington, through the continual wrangling of the small mind who would be a Caesar. This same Caesar found that by playing one recording company against the other, that regardless of the ethics or issues involved, the "recalcitrants" would be forced to accede to HIS demands; the alternative is to be forced out of business. A revolution was fought to safeguard due process of law and to protect AGAINST confiscation of property through phoney taxation procedures. A citizen of this country is led to believe that only political subdivisions have the power to tax. It's about time our school-children were taught the whole truth—we must pay PERSONAL tribute to Petrillo if we are to earn a living in radio or related fields. The networks and independent stations, through the use of the several frequency channels which are public property, have the responsibility of operating "in the public interest, convenience, and necessity." Maximum competition must continue to exist in the programming fields, in the public's best interests. Likewise it is the broadcasters' responsibility to foster total cooperation when any or all of the stations are threatened by the despicable divide-and-conquer theory of such egomaniacs as Hitler. Petrillo has succeeded with the Hitler theory in the Recording field; by threatening to jeopardize one network or one station while leaving the others alone, he is attempting to Hitlerize the Broadcast industry. The several managements of the independents and networks have the very great moral responsibility to themselves as men, and to the public as custodians of public property, to act in total harmony, to lend-lease all of their technical and legal aid to insure that this cancerous blight on the great American Broadcast Industry shall be removed as quickly as possible, by whatever means—**IN THE PUBLIC INTEREST, CONVENIENCE,**

**AND NECESSITY.** It should have occurred to many that there is an urgent need for a **COMPETING MUSICIANS' UNION.** The public was forced to pay for the antics of ASCAP until the industry developed and gave us the BMI, which provided the healthy competition in the field of copyright music. It is very immaterial who sets up the competing Musicians' Union—**BUT IT IS AS NECESSARY AS WAS THE BMI,** if we are to continue with our American-Way Broadcasting—the greatest public service in the history of man. All hot-air balloons come down; we look for Hitler's and Petrillo's to crash.

Under date of Dec. 14, 1944, NABET President Powley advises that NABET intends to abide by the NLRB decision which awarded record-playing to NABET. Petrillo chooses to ignore the NLRB decision, and insists the decision is immaterial to him, since the Networks under pressure of economic strangulation, signed a contract with HIM to provide HIS musicians to play records. NABET obviously had no part of this dubious contract secured from the networks by Petrillo; NABET does not intend to go along with the **PETRILLO APPEASERS;** this would be a treasonous act against the people. NABET intends to apply the necessary **HEAT** that will burst the Petrillo balloon!

Under date of Jan. 10, 1945, NABET President Powley advises that he has received letters from NBC and the Blue that "Mr. Petrillo's interpretation of the NLRB decisions would be their guide." Also contained in the letters is the distorted and well-known quick-switch that the networks are really the victims of a jurisdictional dispute between Petrillo and NABET! The case is so simple that even a Network Lawyer should be able to understand it without benefit of **COMPETENT** legal advice. The title to the property of playing records was clouded. The case was heard, all parties voluntarily participating in the NLRB trial, and all parties submitting all of their evidence. The verdict was given to NABET, **THEREBY CONTINUING NABET's** title to the property of record playing. However, in a secret, power-politics procedure, the Network Attorneys advised their managements that they **COULD GET AWAY WITH SELLING NABET'S PROPERTY TO PETRILLO WITHOUT EVEN TELLING NABET!** NABET will eventually find

(Continued on Page Eighteen)



## TELEVISION IN GOOD SHAPE!

On December 28th, NBC's Television Station WNBT presented, for the first time on any screen, Frances Vorne, Associated Press Pin-Up Girl of 1944. Introduced as THE SHAPE, the name by which she is known to GI Joe around the world, Frances' fame has spread overseas where the British Government has acclaimed her its own pin-up girl for purposes of morale among the men of the armed forces. Frances is 19 years old and was born in New York City. From where we sit, it looks as though television will be a drooling success!—Ed. S.

### FLASH!

## Report of Regional NLRB Hearing in the Petrillo - NBC - Blue - NABET Dispute

National NLRB Examiner — Mr. Howard Meyers  
Regional NLRB Attorney — Mr. Allan F. Pearl

Present were Mr. A. T. Powley, Mr. Martin F. O'Donoghue, Mr. Harry C. Hiller, and Mr. George B. Riley for NABET, Mr. Mark Woods, Mr. Franklin Wood, and Mr. Walter Emerson for American Broadcasting Co. (Blue), Mr. John MacDonald, Mr. Cahill, and Mr. Joseph McDonald for NBC, Mr. Robert Wilson, Mr. Friedman, and Mr. Meter for A.F.M.

The hearing opened at 10:23 a.m., Tuesday, January 30, 1945, in Room 1029-B, 120 Wall Street, New York City, the NLRB second regional offices—on cases No. 2C5735 NBC and 2C5734 ABC (Blue).

The procedure of operation of the hearing was outlined by Mr. Meyers in the cases mentioned, which consist of charge 8 (1) and 8 (5) by NABET against the two companies, and 8 (1) against the A.F.M.

Testimony by Mr. Powley for NABET brought out the facts of refusal on the part of the Companies to recognize NABET as the exclusive bargaining agent for "on the air" playback or turntable operation, and "refusal to bargain."

Testimony of Mr. John MacDonald of NBC brought out the NBC's position which in essence was the threat of Petrillo calling out musicians sporadically if the company bargained with us (NABET), or granted our jurisdiction over turntable operation.

Testimony of Mr. Mark Woods stated the ABC's position substantially in the same manner. However, Mr. Woods stated under oath that ABC did not consider the placing of records, their handling or disposition, covered under the existing NABET-BLUE contract, and they felt that the ABC had the right to give that part of turntable jurisdiction to Petrillo, at his demand.

Testimony given stated that although NBC-ABC and AFM locals had agreed on wages, etc., for AFM personnel, these were never put into effect as no AFM personnel for turntable operation were hired.

NABET's repeated and consistent resistance to any AFM encroachment on turntable operation was established and confirmed by testimony. The companies stated that the so-called contract with Petrillo on turntable jurisdiction was not put into effect on June 1, 1944 because of the strike threat (under the Smith-Connolly Act) of NABET.

The AFM attorney, Mr. Wilson, moved that the AFM claim of "company domination" against NABET be decided before the examiner file his report on this case. The examiner denied the motion.

All witnesses having been called, and with no further evidence to be filed by the companies, NABET, or the AFM, the examiner, after personally asking the above question of each of the parties concerned, moved that the hearing be closed. This was at 4:05 p.m., Jan. 30, 1945.

We hope to be able to announce the decision in our next issue.

—Harry C. Hiller, reporting for The Broadcast Engineers' Journal.

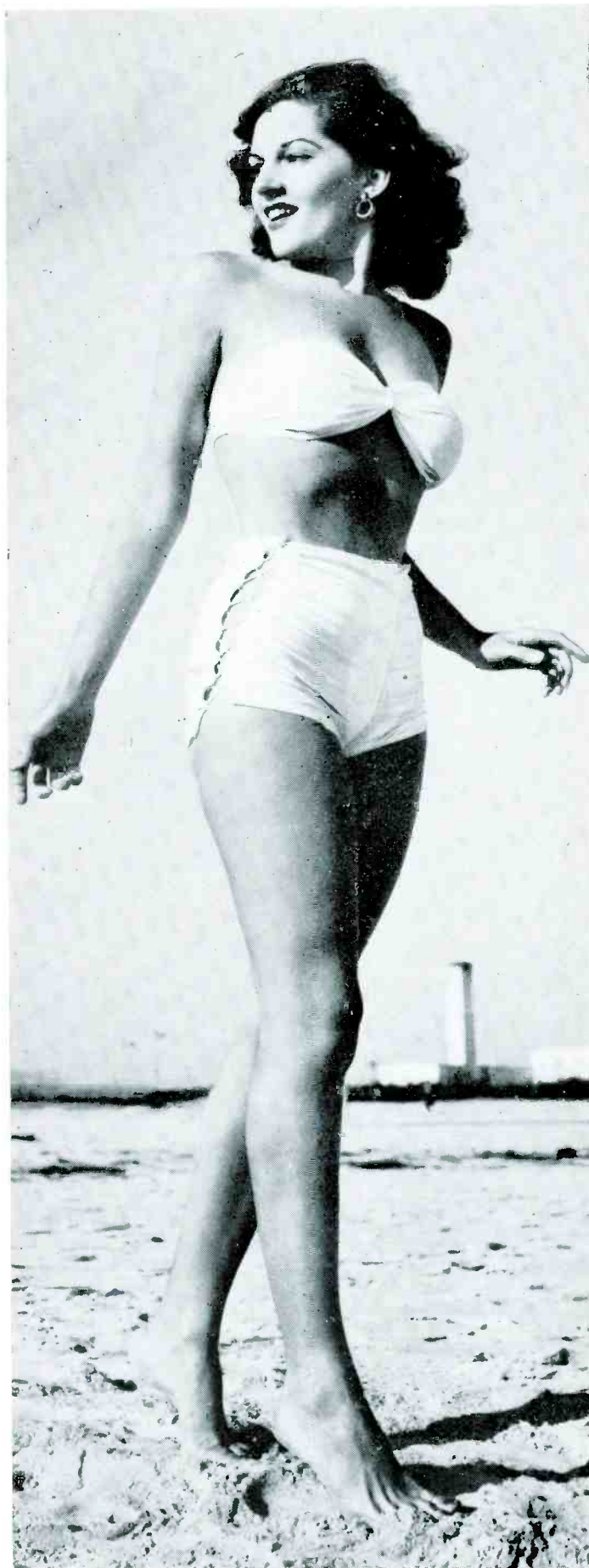

## NETWORK LEGAL EAGLES SELL BROOKLYN BRIDGE TO PETRILLO BEAGLES!!! — NABET Activities Continued from Page 16

it out, and when they do, what can they do about it but accept the polished Hitler accomplishments? THAT'S WHAT THE SMALL BOYS IN THE NETWORK LEGAL DEPARTMENTS THOUGHT! The Network Lawyers went ahead and sold NABET's Record Playing right to Petrillo. THE ISSUE IS SIMPLE, AND IS ALMOST CRIMINAL IN NATURE; THE NETWORK LAWYERS SOLD SOMETHING WHICH THEY NEVER MORALLY OWNED, AND NEVER HAD THE RIGHT TO SELL. THE NETWORK LAWYERS UNLAWFULLY SOLD THE JURISDICTION OF RECORD PLAYING TO PETRILLO. Petrillo, the typical inflated egoist, apparently bought the property of record playing without investigating the title to the property; Petrillo says he has the "bill of sale" signed by the networks. NABET'S legal rights have been fully recognized by the NLRB. NABET didn't sell the record-playing rights; it has no intention of relinquishing these or any of its other precedent-established rights; NOT TO PETRILLO, the LEGAL OFFICE BOYS, or anybody else who wants to agrandize themselves by pulling a fast one on NABET and making it stick. Petrillo's title to NABET's record-playing is as phoney as the dozens of deeds to the Brooklyn Bridge! Petrillo is burned,

and the Network Legal Eagles are trying to get him to take it out of NABET's hide! Is NABET laughing! As Mae West said so very truthfully, "There's a sucker born every minute!" Mr. Petrillo, this means YOU . . . you have been taken over by the Network's Legal Eagles!

Under date of Jan. 16, 1945, NABET President Al Powley advises further increases in the ranks of NABET as follows: WABD-DuMont Television, New York. RCA-Victor Recording, New York and Chicago. WHAM, WHEC, WSAY, WWJ, WHK, WCLE, WGY, WRGB—GE Television, WGFM, KODY, WHFM, WDNC, WGEA, WFBR, WAGA, WSPR, WCAE, WOLF, WRNL, and WMMN. Contract negotiations are under way at several of these stations, and will be reported further as progress is made. NABET has filed 8(1) and 8(5) charges with the NLRB against NBC and the Blue which includes coercion and refusal to bargain on the part of the companies.

We have held going to press for what seemed to be last-minute news on the Petrillo-NBC-Blue-NABET dispute. A hearing has been set for 10 a.m., Tuesday, January 30, in New York. The results will be reported in these pages next month. In the meantime, you can help BURST THE PETRILLO HOT-AIR BALLOON by supporting NABET—ALL OUT!

*(See Page 17 for Report of January 30th Hearing)*

### YEARBOOK CONGRATULATIONS

After every Yearbook, we try to find ten seconds to sit back, thumb thru the book, self satisfied and not particularly caring what anybody else thought about it. This time, before we found the ten seconds, telegrams and letters of praise started to come in from all quarters, congratulating the Editor on a colossal, stupendous achievement, "plastering Nabet's name from coast to coast," etc. To all of you interested enough to comment—Thanks!—and watch the NEXT Yearbook! 'nuff sed.—Ed. S.

The proposed frequency for FM allocation, moving FM from 42-50 to 84-102 megacycles, announced by the Federal Communications Commission on Jan. 16, has helped highlight one phase of pioneer planning at Hallicrafters Company, Chicago, producers of high frequency radio equipment. For the last five years Hallicrafters has had in its standard line receivers that cover both the present FM band and the new band announced in the FCC's proposed allocation plan.

According to William J. Halligan, president of Hallicrafters, as early as 1939 his company's engineering department foresaw the possibility that frequencies much higher

than those then being used for FM might eventually prove superior. It initiated a development program, he said, and announced Model S-27 receiver in the spring of 1940.

This model, covering from 27.8 to 143 megacycles, was designed to receive AM, FM and CW telegraph transmissions. It has since been superseded by Model S-36 which gives similar performance.

"Hallicrafters is the first and only radio manufacturing firm to produce receivers covering these frequencies as part of its standard line," Halligan explained.

"Such models ordinarily would be custom-built as individual units, limited in distribution because of the time required in such type of operation.

"Taking advantage of an excellent engineering setup, we have been successful in applying quantity production to precision-engineered models like the S-36."

Dunford Kelley, recently a staff engineer with the El Monte, Cal., plant of Littlefuse, Inc., has joined the staff of the Universal Microphone Co., Inglewood, Cal., as electro-mechanical engineer. He has been assigned to duties in conjunction with army and navy and postwar production of microphones.



**“The following is electrically transcribed..”**



**on PRESTO discs!**

Pepsi-Cola's bouncy little ditty seems likely to become an American folksong. It has been played on the air more than a million times since 1939. You've heard it in swing-time and in "classical" versions for the intelligentsia. It has made Pepsi-Cola a buy-word in homes throughout the nation.

Pepsi-Cola "spots" are cut on PRESTO discs. *Most*

*important transcriptions are.* For recording engineers know that PRESTO discs give finer results with less margin for error—*actually perform better than most of the recording equipment on which they are used.* That's why you'll find, in most large broadcasting stations, recording studios and research laboratories, the standard recording disc is a PRESTO.

**WHY BROADCASTING STUDIOS USE MORE PRESTO DISCS THAN ANY OTHER BRAND**



*Less Surface Noise*

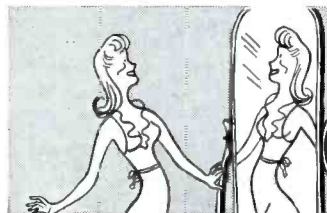

*No Distortion*

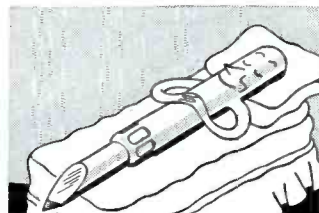

*Easier on Cutting Needle*



*No Fussy Needle Adjustments*

**WORLD'S LARGEST MANUFACTURER  
OF INSTANTANEOUS SOUND  
RECORDING EQUIPMENT  
AND DISCS**

**PRESTO**  
**RECORDING CORPORATION**

242 West 55th Street, New York 19, N. Y.

Walter P. Downs Ltd., in Canada

# from San Francisco

**S**AN FRANCISCO engineering seems to be going to the horses, if we can alter an expression. **Guy Cassidy, SE**, purchased a pony for his son's Christmas but, being more impatient than his son, brought the mare home before December 25, debunking the child's hypothesis that Santa would be unable to deliver the pony due to the small bore of the chimney of his house. Gas rationing may yet cause Cass to reach for his boots and saddle, depriving junior of his Xmas present, while "Buck Cassidy Rides Again". **Harry "the Horse" Puccetti, SE**, trainer and agent for Cassidy Stables, boasts an "on the nose" average at Tanforan, Tijuana, Milbrae, and all points East, West, etc., etc. The hitch is that Harry seems to forget to cover his "cinches" with the coin of the realm. But Harry has other talents. He has developed the "Puccetti Treatment" guaranteed to arouse the demon-like temper of his patients. His chiropractic massage consists of stiffening the forefinger and index finger and with jack-hammer force, tapping the chest of his victim while conjecturing in a Windy City accent, "Hey, character, where you think you're going?"

Speaking of doctors, the members of the engineering staff have been keeping them busy these days. **McDonnell, SE**, boasts a new daughter, **Bob Shover, RE**, finally a son, and **Rod Hawkink, Apprentice**, a daughter. Congratulation. **Sam Melnicoe, TE**, who transferred to the Dixon transmitters, worked out of the San Francisco purchasing office before reporting for duty at the transmitter. The lure of the open country and rural life of Dixon has been tempting **Senator Watson, SE**. The senator has long been expressing a desire to have a place in the country where all there is to do is to fish, hunt, eat and sleep without the radio to bother him. **Clark Sanders, SE**, our engineer turned war correspondent, has been home on leave over the holidays from CINCPAC. Glad to see **Russ Pray, SE**, back on the job after a recent illness. **Verne Harvey, FE**, didn't put in an appearance very often last month due to his extended junkets into the Northwest so we can't report on Verne. We are sorry to report that

By  
Jack Van Wart

**Andy Wauchope** has resigned from the KPO transmitter.

The housing problems continue to cause no end of consternation among the engineering staff. **Andy Mitchell, RE**, decided that he lived too far away and sold his San Mateo home. Now he is faced with the baffling problem of locating new quarters. With the aid of **Toby Hamma, SE**, and the San Francisco Police Department, **Frank Oliver, SE**, was able to take possession of his newly purchased Clay Street home. The first action was a court order secured through the excellent legal work by **Toby Hamma** and the second action was the forced eviction of the tenant with the assistance of the riot squad. **J. A. O'Neil**, Recording Supervisor, returned from a week in Southern California inspecting the facilities and operation of the Hollywood

## News from KGO Transmitter

**Myron Case, TE**, returned to his place on the KGO transmitter staff at the beginning of November following his release from Columbia Research Labs back East. Myron has been experiencing the agony of ferreting out living quarters where there are no living quarters, spotting a car for transportation in a market where the ceiling is as high as a barrage balloon and sweating out the delivery of his household belongings over war-choked rail systems. . . . **Henry Dunton**, who has been with KGO since its inception, has been promoted to station engineer in the vacancy created by the recent promotion of **Shorty Evans** to Managing Engineer of KGO. He has the hearty good wishes and congratulations of all who work for and with him. . . . **Jim Blanchet** is sporting some new and interesting "Moom Pitchers" and his popularity as the stations outstanding "Shutterbug" is well deserved. . . . Visitors. . . . From the studios we



studios. **Russ Butler, SE**, is back from a short honeymoon in Santa Cruz after his marriage to **Jan Kenyon**, well known to local listeners of KLS. . . . The Blue Engineering staff welcomes **Wylie A. Paul, SE**. Wylie has had varied background in the field of communications. His past positions include RCAC in San Francisco; Westinghouse in Baltimore; Tropical Radio Telephone Company in Boston. He also was in the Navy as a war radio electrician, from which he has a physical discharge. . . . KPO transmitter staff welcomes two new members—**Wendell B. Seward**, formerly with WSCS Radar Branch at Davis, Calif., and **Ralph C. Kennedy**, formerly with the Hewlett-Packard Manufacturing Co. in Palo Alto, Calif. The studio group of NBC has a new apprentice in the person of **Dale Gorden**.

By Ken Martin

were honored with a gabfest with **Russell Pray** who came over to see if it was really here as advertised. It is. . . . **Bob Nelson, Ex. TE**, now in Merchant Marine, came in in a natty uniform to shoot the breeze. He's been places and back. . . . **Hervey Fritch, ex TE**, mustered out of Navy V-12 program because of reduced requirement for pilots returned to his second love, the Merchant Marine, sailing on the S.S. West Wind, destination, unknown. . . . **Herb Kramer**, our councilman, has invented what I choose to call rubber gasoline. Anyhow it S-T-R-E-T-C-H-E-S. This formula may be had by contacting Herb. Herb is noted for having a hearing range higher than the normal average. He detects HF squeals clear off scale, that bother no one else because they are above the audible range.

Your reporter has been enjoying (?) removal of moles and has been "spot-welded" by the HF needle so often. I'm about ready for a Kaiser launching.



# OMAHA NEWS . . . By Bob Rudd

**J**OSEPH LOUIS HEROLD was born on a farm near Hamlin, Kansas, March 8, 1907. His life, like that of most farm boys, was filled with plenty of hard work and there was little time left to find the answers to the problems that entered his head.

Joe had several older brothers and sisters and one younger brother. It wasn't until his older brother was in high school that Joe became interested in



Joseph Herold

things electrical. Joe was about fifteen. It was the year 1922. Older brother Carl was taking Physics in high school and from time to time brought home

books on various scientific subjects for purpose of study. Joe being exposed to these books, took great interest in them and found the subject matter highly entertaining as well as informative. They gave him the answer to how the family party line phone worked, how the spark coils in the model T worked and what made the batteries generate an electric current. Joe tells of the phone that he and his brother had rigged up between the corn crib and the house. Parts were removed from the regular phone. In the absence of Mother and Dad of course, and were used in their private phone line. The parts were always back in the phone before Mother and Dad arrived home. With the older brother quit a bit of the head work and Joe doing a lot of the leg work, this sort of thing went on until Carl graduated from high school.

Joe decided that the scope of the physics text was too limited and decided to take a correspondence course in radio. In 1925 he started taking the course offered by the National Radio Institute of Washington, D. C. The basic theory and experiments, along with the equipment sent to him as the lessons progressed, enabled him to build

and repair radios for his neighbors and friends.

In 1926 at the age of nineteen, Joe left home and entered the School of Engineering in Milwaukee, Wisc. An EE degree was Joe's aim but after six months of schooling, he was forced to quit. A mastoid infection made it necessary to return home where an operation was performed which corrected the infection, but left Joe without funds to return to school and to complete his education. He remained home for two years, saved his money, and then set out again to complete his education. This time he entered Dodge Institute in Indiana. The training he had received at the Milwaukee school was so thorough despite his short attendance, that he progressed rapidly and in a short time obtained his first license, known then as "Commercial Second". After only two months he was able to copy American Morse at thirty WPM, having copied Continental Morse at the rate of sixteen WPM at the end of one month.

His first job after leaving school was as a ship operator aboard the SS "Puritan" out of Chicago, and later aboard the SS "Alabama". Perhaps some of you old timers remember these ships.

In 1930 he decided that he would like to get into some other phase of radio and at the same time get a little nearer home. January 28, 1930, he landed a job at WOW, then a share time station in Omaha. The WOW of that day was using a WE6B transmitter with a 228A in the final. Joe's ship experience stood him in good stead here as part of his work was copying Morse over the NBC circuit. This was before this writer's time at WOW but some of the old timers say that Joe could copy along with the best of them and wrote it all out in long hand. Sometimes his writing looked like a wavy line but Joe always knew exactly what he had written and never had any trouble writing it into message form.

Joe applied himself well and soon had mastered the old 6B. He knew it like the palm of his hand. When WOW decided to move and change power in 1935, Joe was made Assistant Chief Engineer. He and Chief Kotera installed the entire studio and control room equipment. They worked night and day and when the time came to

switch from the old studios to the new, everything worked, though some of it was haywired up temporarily awaiting the arrival of back-ordered equipment.

As WOW grew the necessity of recording equipment was felt and Joe installed a Universal professional recorder. This is a far cry from the modern recording room that WOW now has. Four recorders with suction equipment, complete mixing and switching panels are now in use. The recording room installation is Joe's baby and he has done a marvelous job.

Though all the engineering crew felt that Joe was confirmed bachelor, he surprised them all by marrying Miss Lillian Dixon of Detroit, Michigan, on January 28, 1939. Mrs. Harold was, at the time of her marriage, secretary to Mr. Harry Bannister, manager of WWJ, Detroit. Joe and Lee celebrated their sixth wedding anniversary last month.

Joe's hobbies are hunting and thinking up new ideas to improve his home. His home on Pierce Street is delightful and comfortable and contains many labor-saving devices that he has rigged up. One of these is self opening garage doors that he can open from his car. A broadly tuned receiver in the garage and a record player in the car turns the trick. This saves Joe a lot of trouble and you must admit it is a labor saver. The outdoor kitchen furnishes a delightful spot in the summertime for picnics and the whole thing including oven was built by Joe.

Joe starts his fifteenth year with WOW with a new title. Instead of Assistant Chief Engineer, it's now Technical Supervisor. He was advanced to that position January first. Joe is looking to the future and to adapting television to the field of activities of WOW. He informs us that he will, by the responsibilities of his work, be required to resign from NABET but that his heart will always be with the boys.

President John Gillin, Jr., is back on the job after spending a week (November 27 to December 6) in St. Joseph's hospital, recovering from an operation.

According to Joe Herold, the new Presto Recording heads really turn out high fidelity cuttings. Installed the first part of December, WOW's recordings have taken on new life. Curves run on

(Continued on Page Twenty-Two)



**PERMOFLUX** *First*  
with a *Complete*  
**SPEAKER LINE!**

**2" to 7½" Diaphragms in ½" Steps  
plus 10", 12" and 15" sizes . . .**

No longer will it be necessary to choose a dynamic speaker to accommodate design requirements "as nearly as possible." The new Permoflux line of "true dimensioned" speakers covers the entire size range - there is a unit engineered to the exact needs of every design - there are speakers to provide power handling capacities from 1 to 20 watts. Incorporating exclusive Permoflux acoustic principles developed for war, these speakers mean new efficiency and tone revelation. Our engineering department invites consultation on your postwar sound design problems.

**BUY WAR BONDS FOR VICTORY!**

TRADE MARK  
**PERMOFLUX**  
PERMOFLUX CORPORATION  
4916-22 W. Grand Ave., Chicago 39, Ill.

**PIONEER MANUFACTURERS OF PERMANENT MAGNET DYNAMIC TRANSDUCERS**

**OMAHA**

(Continued from  
Page Twenty-One)

the heads show a flat response from 30 to 9,000 cycles. Its quite possible that the increased fidelity might not be noticed by listeners with the average receiver but the difference between the old WOW recordings and the new ones cut with the Presto heads, can easily be detected on Joe's 23 tube Scott radio.

The WOW gang with guests Tom Daily (Sports Anncr.) and Eldon Wesley ("Your America" artist) were treated to a fine steak dinner at Marchio's by TS Joe Herold and Chief Control Operator Glenn Flynn. Wesley, not being a member of the "Dead-Beat" club, was invited to join. This he agreed to do because its "so obvious that this club is a great benefactor to mankind—especially the WOW kind". We didn't have to maul him over ten minutes to get this unbiased opinion from him. Ha!

**WOW STAFF PARTY**

President John Gillen, Jr., and the directors of radio station WOW gave a party to its 62 member staff at the Blackstone Hotel, December 16, 1944.

The setting was most appropriate for a party. Win-

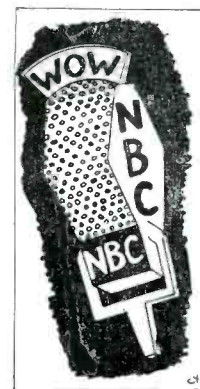

dows on three sides overlooking the city, growing shrubbery and plants all around the room, round tables covered with snowy table cloths and sparkling silverware, a portable steam table and serving counter had food to offer just for the asking: the

entire room in shimmering white with contrasting red, made an ideal party atmosphere.

The festivities started at noon and as each member entered the room he or she was presented with a check for \$25 as a Christmas present, and a pin symbolizing WOW and its affiliation with NBC. Cy Hagrman's sketch of the pin appears above.

It was a gay affair and laughter and chatter could be heard everywhere. Little groups were all over the place rehashing old days or telling favorite stories.

Dinner was served about 2 P. M. The menu was chosen to fit the season.



Turkey, baked ham, olives, cranberries, mashed potatoes and gravy, pickles, hot rolls and coffee made the dinner an outstanding success!

After dinner was over, **President John Gillin, Jr.** awarded Ten Year pins or rings to all of the employees that had been with WOW for ten years or more. **Tom Chase** (Transcription Dept. Mgr.), **Roy Glanton** (Transmitter Supervisor), **Bill Kotera** (Chief Eng.), **Joe Herold** (Tech. Sup.), **Harry Burke** (Stn. Mgr.), **Lester Palmer** (Municipal judge, and still doing some announcing), **Helen Lewis** (Tfc. Mgr.), **Luella Cannam** (Sales Dept.), and **Betty Bauer** (Scty. to Harry Burke), were awarded the coveted honors. Most all of them have been with WOW closer to fifteen years than ten. Mr. Gillin announced that twenty years pin or rings would be awarded when twenty years of service to the company had been completed.

The outstanding event (at least to the engineers) was the announcement that **Joe Herold** had been advanced to the position of **Technical Supervisor** and **Glenn Flynn** to **Chief Control Operator**. The entire staff extended **Joe** and **Glenn** hardest congratulations.

The party came to an end at approximately 4:45 P. M., but the memory of the fun and fellowship that existed there will never be forgotten. In our opinion, it was one of the best parties WOW has had in many a year and we wish to thank **President Gillin** and the Board of Directors for the fine time shown us and for the Christmas present.

#### COUNCILMAN "TEX" GLANTON BACK ON JOB

Councilman "Tex" Glanton, ill several months with sciatic rheumatism, entered St. Joseph's Hospital December 2, for treatment. Tex had stayed on the job despite terrible pain and from time to time thought that he was improving, but he was finally forced to enter the hospital after trying all sorts of treatments and adjustments.

His ailment started in the spring of 1944 and gradually grew worse. He was finally forced to his bed and for several weeks he lay there with the thought that he would get better. The pain grew worse from day to day. He was under treatment all this time and everything was tried to alleviate his condition.

Removal to the hospital was necessitated after several days without sleep and an inclination towards delirium. The last few days at home were spent

(Continued on Page Twenty-Four)

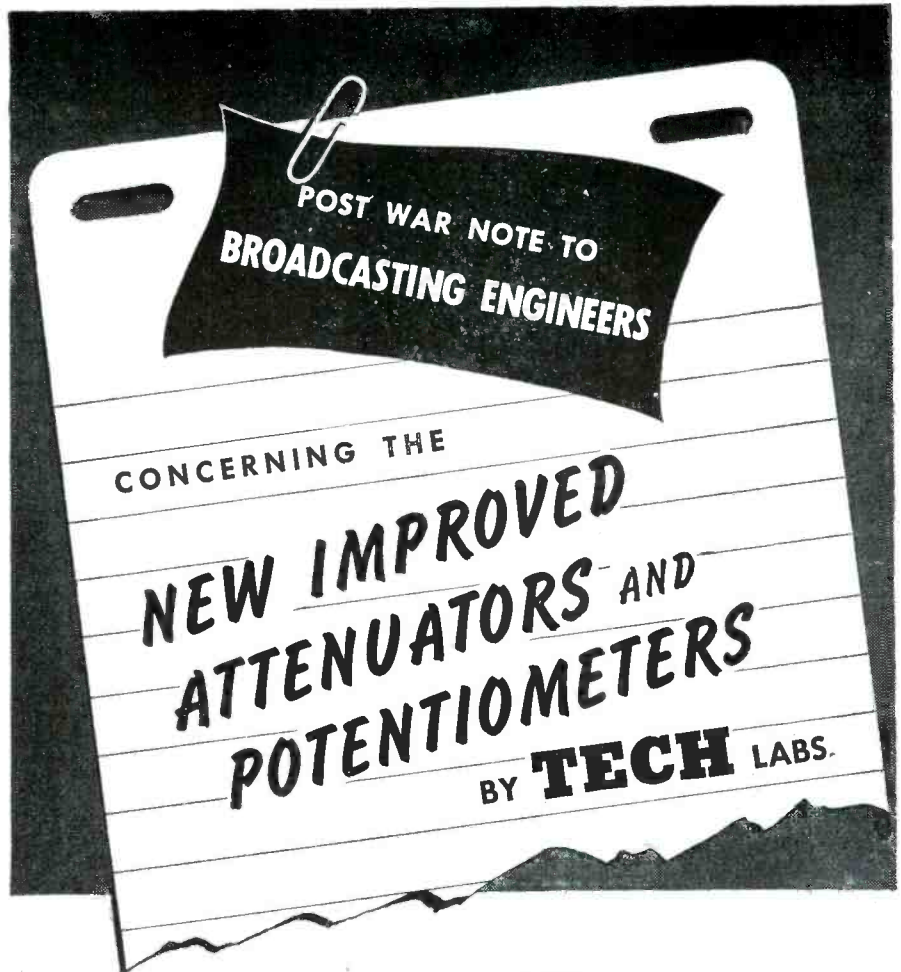

All our modern production facilities, manpower and materials are engaged in supplying our armed forces with quality electrical resistance instruments. Once the Victory has been won, Broadcast Engineers everywhere can rely on Tech. Labs. for prompt shipment on precision attenuators and potentiometers.

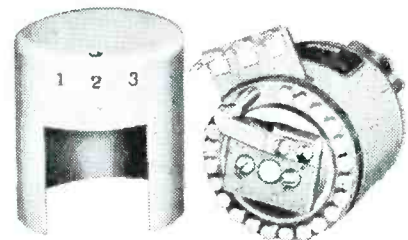

TYPE 600

- Stainless silver contacts and wiper arms eliminate the necessity of frequent cleaning and result in less noise.
- Better insulation and moisture proofing result in superior performance.
- Improved mechanical construction — pinned rotor hubs and detent gears—results in longer trouble free operation.



TYPE 700



MANUFACTURERS OF PRECISION  
ELECTRICAL RESISTANCE INSTRUMENTS

15 LINCOLN STREET, JERSEY CITY 7, N. J.

## OMAHA

(Continued from  
Page Twenty-Three)

under the influence of sedatives and hypnos.

At this time **President John J. Gillin, Jr.**, was also in the hospital. He heard of **Tex's** condition and decided that a specialist was needed. He arranged to have a neurologist examine **Tex**. The neurologist found the seat of the trouble comparatively soon and advised surgery. After a week's consultation between **Tex's** family physician and the specialist, an operation was decided upon.

The operation was performed December 14. **Tex** came out from under the anesthetic six hours later a relieved but exhausted man. His improvement was rapid from the very first day. The pain was relieved and other than some pain in his back at the point of surgery, he felt practically normal again.

Most of the staff that were able to visit him, did so and the others unable to do so sent him cards and flowers. The staff figuring that perhaps he would be in the hospital on Christmas Day, got together and sent him a shower of gifts. It was learned that he was to be released on Christmas so the gifts were sent to his home and were there when he arrived. He received in a large package thirty-one gifts of various and sundry items—books, magazines, pencils, shaving lotion, cigarettes (hummm), candy, etc.

In a letter to the staff he said in part:—"I was released from the hospital Christmas morning. It was a beau-

tiful day, especially for me, to be home once again with my family, and to enjoy a swell Christmas dinner. You couldn't do enough while I was in the hospital; all of you had to play Santa Claus, and when I got home I found a large box of presents (31). I was overwhelmed."—"Once again, thanks a lot. I shall always be grateful."

We are all glad to see **Tex** back home again and hope that he never again will have to suffer as he has the last nine or ten months.

### KOWH ENGINEER BURNED

Another Omaha radio man was confined to the hospital during December. **Nels (Pete) Nelson**, Transmitter supervisor of KOWH (Blue) received a charge of high voltage electricity while making emergency repairs on the transmitter.

As Pete tells it, he was called in by operator **Myrle Jones** to replace a burned out "C" bias resistor. Pete shut off all voltages and proceeded to check for the trouble. He had just stepped around to the rear of the transmitter when the charge struck him.

He was unconscious for eight minutes and then recovered. From what **Jones** tells him, Pete was out of his head and attempted to get up and run to his apartment. **Jones** attempted to stop him from moving about but had quite a job holding Pete down.

**Jones** had called the inhalator squad as soon as it happened and it wasn't long before they showed up. They removed Pete to the hospital where they found he had sustained severe burns

and cuts. His left hand was badly burned and he received a scalp wound as a result of being thrown against the transmitter frame. A burn on the wrist of his right arm was received from an identification bracelet he had been wearing.

There seems to be no doubt of his rapid recovery but just as a precaution, his doctor kept him hospitalized until after the first of the year. We all wish Pete the best and hope he will be back on the job soon.

**President and Mrs. John Gillin, Jr.**, spent their Christmas with **Mrs. Gillin's** parents in McCook, Nebr. The staff purchased **John** some fishing tackle and mailed him a certificate that will permit him to select what he wishes when he so desires. As **Harry Burke** (Station Manager) said—"We want to make sure he will be out of the way for two weeks next summer." Ha. Good fishing, **John**.

### CONGRATULATIONS

Congratulations to **Al Maller** as he starts his third year at WOW. **Al** started February 6, 1943. Happy birthday to **Waldon Sieh(se)** who will be 27 on February 6. No congratulations to **Rudd**, but he will be 36 February 3. A resounding cheer to **Joe Herold** and **Glenn Flynn** on their recent promotions. **Joe** is now **Technical Supervisor** and **Glenn** **Chief Control Operator**.

### OOPS

Our face is a bit red for missing the December issue of the journal. A misunderstanding on the deadline date caused the slip up.



Output switching panel in WWJ Main Control Room.

## DETROIT NEWS By Dave Stewart

**H**ERE 'tis time to get the gossip out and as usual we're late—

Starting February 1st, WWJ adopts its new policy of banning all one-minute and chain break transcribed announcements. We know it's a terrific break to us—no more of these rat-races, playing E.T.s, and having to check and re-check these nervewracking platters with their fog-horns, whistles, and other sound effects, used by the producers of these headaches, to attract your attention to products far removed from the sounds used. Production in Detroit's war plants should go up to unprecedented heights now that the war workers' nerves will no longer be shattered by these monstrosities we've been heaping

on the listening public under the guise of "radio."

Frank Koster terminated ten years of service with WWJ on January 6th. Frank is leaving Detroit and heading for California with his family, and we will miss his arguments around MCR—Best of luck, Frank, and we hope to see news of you from some of the west coast chapters in the near future.

Captain LeRoy C. Bridgman returned from two years in service with the Signal Corps of the Army of the United States in England, where he worked with the Army Network since its inception. Roy is being mustered out and should be back in harness at WWJ in the very near future.



As we predicted, Ole Lapham came back from Northern Michigan without a deer. . . . Studio facilities at WWJ are undergoing a face-lifting by having the mixer enlarged to 10 channels and should keep producers up nights figuring ways and means of using 10 micro-phones on a show that normally requires two; however, we're of the opinion

they'll still have to have very good reasons for setting up forests of micro-phones in a studio.

WXYZ is in the process of rebuilding their output switching system and the boys out there are looking forward to the day when they don't rush around MCR with a handful of patchcords.

Bill Walker was in on a visit for a

couple of days from New York during the holidays, and Junior Moorehouse, after trying madly to get a furlough for Christmas, finally compromised by spending a month's pay on a long distance phone call from Great Lakes, and managed to talk to everyone on the WXYZ staff.

## from Rochester Chapter NABET

By Arthur Kelly

**T**HE one and only topic of conversation in the Rochester Chapter, since last month, was the weather—but definitely! Not only have new weather records been set in the Rochester area, but a few records have also been set in the local field of broadcasting.

Some jester of another year is given credit for having said that January thaws. Well, that may be, but the ops in the Rochester area have got to be shown. At this writing, the month of January has done nothing that December didn't do . . . and December did everything in the books. Right about here, in the middle of paragraph two, many of you guys may be wonderin' what this guy Kelly does. You wonder does he write local "color" copy or does he write about the Rochester gang. As a matter of fact, this is all leading up to a swell story that I hope will pay tribute to all the guys in the local chapter.

Now the boys out around Denver may think lightly of an Eastern snow-storm, but we don't give a hang because we think we know of what we speak. At least residents of Rochester already talk about "the storm" the same way Johnstown talks about its flood. A legend has been accepted into the city's history within the short span of four weeks.



To be specific, Mother Nature opened the main gain in the snow department on December 11th and 12th and really laid it on to the extent that the city was virtually paralyzed. Transportation was at a standstill, the downtown stores were closed. War plants stopped production

because the workers couldn't get to their jobs. Everything stood still, except the radio stations. The finest traditions of radio were upheld by the ops who walked miles to work, who stayed on duty, day after day, keeping things going until the other boys could dig out (and the streets were dug out, or at least opened up) and normal tricks could be resumed. I'm not going to pat any one op on the back specifically because practically every operator deserves a good word and space just doesn't permit such a long discussion.

All three stations, WSAY, WHEC and WHAM, did themselves proud by announcing the closing of schools, postponement of civic meetings, cancellation of shifts in war plants, road information, bus information, emergency medical information, etc.

The enclosed picture is representative of the spirit of the gang in the Rochester Chapter during "the storm." The gentleman in question is WHAM transmitter operator Alex Gressens. That's the snow-bound WHAM transmitter in the background. Alex is carrying in a few supplies just in case he gets hungry. It's general knowledge that Alex even takes a few sandwiches along with him to banquets—just in case he gets hungry between courses.

## HUDSON CHAPTER NEWS

By Richard H. Davis

**H**APPY NEW YEAR greetings, etc. . . . This being the new year, we open one eye and vow to make several resolutions, note them and then file 'em in the right hand coat pocket. . . . Looking back, it certainly looked good for Radio until the last week in December . . . well guess we'll have to finish up that mess in Europe and Asia before those dreams can even partly mature . . . the Sixth War Loan

was excellently supported by the Engineering Department. . . . The transmitters were 100% enrolled.

Mr. J. R. Poppele, Chief Engineer of WOR and WBAM, was coordinator for the first annual conference of the Television Broadcasters' Association at the Commodore in N. Y. He was subsequently elected to the president of the Association for the year 1945. . . .

Mr. T. C. Striebert was elected to

president of Bamberger Broadcasting Service operators of WOR and WBAM. Mr. A. J. McCosker, former president, was elected board chairman.

After a number of ballots at the Carteret Transmitter, several of which resulted in dead heats, Frank Garuffly was elected councilman for that group.

"Hax" Hadden, MC, has finally finished his "V Bomb Room," and now is

(Continued on Page Twenty-Six)

# BROADCAST STUDIO EQUIPMENT

## SHIPPED FROM STOCK!\*

★ ★ ★ ★

### Altec-Lansing Duplex Loudspeaker (Model 605) Just Out!

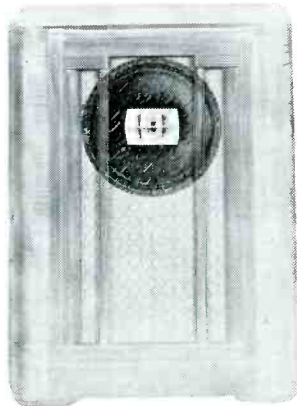

A new compact 2-way multi-cellular loudspeaker combining both high and low frequency units. Provides up to 1200% increased area of distribution. Features 20 ohm dividing network used with a cross-over frequency of 1200 cycles for separating power for each unit. 25 watts capacity. Modern beautifully finished walnut cabinet 38 x 30 x 16"—eight cubic feet of air space. Net Price **\$330.00**

### Model 816—Iconic Loudspeaker

(Not Illustrated). Electro-dynamic two-way loudspeaker with dividing network, power supply and separate high and low frequency units in beautiful polished walnut cabinet 34 x 35 x 20". Input impedance 12 ohms. Frequency response 30 to 15,000 Cycles. See **\$296.00** and hear it at our premises! Net Price...

### Jensen Co-Axial Reproducers

#### MODEL JHP - 52

15" high quality PM co-axial speaker for FM-AM broadcast monitoring, transcription playback, phonograph reproduction, etc. Frequency response 50 to 12,000 cycles. Input impedance 500 ohms. Will handle 12 to 14 watts. Complete with h.f. range control switch, escutcheon and knob. Net Price **\$29.70**

#### MODEL CRJ - 52

Illustrated at right. Consists of the above described JHP-52 co-axial speaker mounted in a beautifully designed walnut finished bass reflex cabinet equipped with h.f. control knob. 27 3/4" x 31 1/2" x 14". Net Price **\$58.95**

#### MODEL JAP - 60

A 15" PM co-axial speaker with somewhat higher efficiency than the JHP-52. Essentially smooth response from 50 to 15,000 cycles, cut-off slope of 10-12 db per octave. 500 ohm input. Will handle 14-15 watts. Net Price **\$42.00**



### IMMEDIATE DELIVERY ON AMPLIFIERS!

STROMBERG-CARLSON model 20 — 30 watt amplifier with tubes	\$ 59.25
STROMBERG-CARLSON model 21 — 50 watt amplifier with tubes	106.25
STROMBERG-CARLSON model 22 — 50 watt booster with tubes	77.25
WEBSTER-RACINE model 11-12 — 12 watt amplifier with tubes	50.01
WEBSTER-RACINE model 16A20 — 20 watt amplifier with tubes	66.50
WEBSTER-RACINE model 18-50 — 50 watt amplifier with tubes	109.50
BOGEN model E1620 — 20 watt mobile amplifier, 110 V.A.C., 6 V.D.C.	94.35
BOGEN model E30 — 30 watt amplifier with tubes	56.25

Also many others in stock. Write about your needs.

### Pick-Ups, Loudspeakers, Accessories, etc.

BRUSH model PL-20 hi-fidelity crystal pick-up	\$27.00
BRUSH model RC-20 crystal cutting head	15.00
SHURE model 44a magnetic cutting head	7.00
WESTINGHOUSE model NC-35 d.b. meter	18.40
CINAUDAGRAPH WM-13-23 15 watt 13" PM speaker 2 1/2" v.c.	43.50
CINAUDAGRAPH PM12-23 12" PM speaker, 10 watts capacity	8.50
STROMBERG-CARLSON model 33717 — 8" PM speaker, 7 watts	1.00
TALK-A-PHONE model LP-5 Master inter-communicating station	20.10
TALK-A-PHONE model RS-3 Remote Station for use with above	7.50

Also many other models available.

\* Orders must necessarily be accompanied by priority rating certifications.

### Hundreds of Hard-to-Find Items in Stock

Write to us regarding your specific problems. We can help!  
New York's Oldest and Most Complete Radio-Electronic Supply House

**SUN RADIO** & ELECTRONICS Company  
212 Fulton St., New York 7, N. Y.  
Telephone BA rclay 7 - 1840

## HUDSON NEWS

(Continued from Page Twenty-Five)

awaiting proper liquid requirements for the grand opening. . . . He still has some cigarettes . . . early 1944.

Da Costa, RE, is starting a collection of empty cigarette packages as a souvenir of the Great Cigarette Shortage. . . . He now has 50 different brands, some of which actually had tinfoil liners. . . . Never knew some of the brands existed. . . .

Mac Benoit, S.E. "Superman," spending spare moments writing music, he has his eye on making a hit via a singing commercial. . . .

The WOR transmitter had some real excitement on Dec. 7th when a beserk murderer killed four persons and wounded two others about a mile away from the station in Carteret.

The madman hid in a railroad-tie storage yard in an apparently impregnable position. The authorities called soldiers from nearby Camp Kilmer, the N. J. State Police and a cordon was thrown about the entire area.

Dave Driscoll, WOR director of War Service and News, came in from New York and with a Mobile Short Wave Unit, WMOR was about to accompany the police through the surrounding tall bush land in an effort to flush out the killer. However, just at this point, the murderer gave himself up at Woodbridge, four miles away.

Driscoll came back to the transmitter and put on a special show with eye witness accounts for WOR listeners.

Geo. Robinson, Acting Supvsr, TE, said that it looked like WOR was in the middle of the war. . . .

### CHANGES

Ed Leach, formerly SE, switched to program department in capacity of Production Supervisor.

Bill Warneike, ex-SE, now doing special work out on Long Island.

Gus Gustavson, ex-Sound Effects, now making noises at Blue.

Lew Tower, ex-MC, now with Mutual as Supervisor of Engineering Traffic.

### NEW FACES

Dave McKee, formerly of American Airlines, now in studio operations. . . . he is now down to earth. . . . hi. . . . Carl Berry, ex-U. S. Signal Corps, at Transmitter in Carteret. . . . Toots a sax on various and sundry occasions. . . . R. Harper in Sound Effects. . . .

Sound effects. . . . A Penner recently a proud popper of a nice baby girl. . . . Glad to hear everybody is doing fine. . . . even the pappy. Jim Goode and Sam



Morse looking for the Marching Feet effect that walked along . . . a long, long, trail . . . hi.

Recording . . . Paul Baldwin, Rec Supervisor, turning out copious Phono masters which are super. . . . How do you like the midnight shifts. . . . R. Schlegel now quite a philatelist . . . stamp collector to you . . . having caught the bug from his young nephew whom he started. . . . hi. Danny Conover, councilman from Recording, now looking for dues, nuff said fellows. . . . Bob Dougherty, who does Aunt Jenny and Rosemary discs, now off on weekdays and has to keep close to the radio in order to keep fresh on the story. . . . Free Ad . . . F. Ennis, the Recording Department Television expert, looking for a "Yoke" . . . "Stretch" Lee and Geo. Cory just what the doctor ordered in the installation of the new intertalk system. . . . Lee, in the hanging ceilings, and Cory on the high wires! Bill Delaney forced to resign due to illness. Good Luck, Fella. Yeomans still tangled up with WERS, etc., don't these hams get tired of radio?—CUL.

News Release Number 79846

**FEDERAL COMMUNICATIONS  
COMMISSION**

Washington 25, D. C.

January 4, 1945.

As a convenience to many licensed and formerly licensed commercial radio operators now in the military service or employed in war industries distant from their homes, who do not have actual possession of their licenses and cannot ascertain their expiration dates and therefore cannot file timely applications for renewal, the Federal Communications Commission by adoption of Order No. 124, extended for a period of one year from date of expiration of commercial operator licenses (other than Temporary Emergency Radiotelegraph Second Class licenses), the time within which applications for renewal filed prior to December 31, 1945, may be accepted.

This order should not be construed, the Commission pointed out, as authorizing continued operation under the terms of any radio operator's license after the expiration date thereof.

Attention is invited to the provisions of Sec. 318 of the Communications Act requiring that the actual operation of all transmitting equipment of any radio station for which a license is necessary, shall be carried on only by a person holding a valid operator's license of the proper class . . .

A

A



**ALLIED**

*The Name to Remember for  
Quality in Recording Discs*

**ORDERS SHIPPED PROMPTLY**

**ALLIED RECORDING  
PRODUCTS COMPANY**

21-09 43rd Ave., Long Island City, N. Y.

Phone STillwell 4-2318

Cable: Allrecord, New York

# from HOLLYWOOD

By Norman Dewes

SMOG — Vital Statistics — Visitors — Parties — Television — Movies — Blue — New Shows — Gossip

**C**ALIFORNIANS . . . Have a word for this ceiling zero weather we've been having lately, wherein you can't see a foot ahead, yer hand in front of yer face or anything else . . . in fact, yuh can't see nuttin' . . . they call it Smog, a conjunction of smoke and fog, and the local weather forecasts are even given as " . . . heavy Smog tonight and Sunday," etc. . . . you can be driving down the street with everything all lit up and can't see a darn thing but a dense white cloud . . . we used to call it being "in a fog" or "all fogged up," but now we say "smoggy as H— tonight, ain't it?" Authorities describe it as " . . . a combination of low-hanging clouds, a bit of fog, inverted temperatures and smoke and fumes from industrial plants, locomotives and diesel trucks," and as reported in this column last December, so far haven't been able to do anything about it. We have found a solution which works perfectly, however . . . a few weeks ago while driving aimlessly around, looking for possibilities, we discovered a joint up on La Brea Avenue, just around the corner from the boulevard called the "Fog Cutters" . . . purely out of curiosity we went inside, and it turned out to be a tavern where they serve you potions of the same name. Still curious, we had one . . . and when we came out we couldn't see the fog at all . . . in fact, we couldn't see anything and had to be led home. There was a regular pea-soup fog that nite too, which suggested another name for those things . . . they really cut it . . .

**STATISTICS**—It's a boy at the **Ross Miller's** . . . **Ross Jean Miller, Junior**, five pounds ten ounce and at 1:30 ayem on December 20, just in time for Christmas. **Dorothy** and **Junior** doing well at St. Vincent's and **Ross** passing out . . . big fat hand-made SEEgars. **Father Miller** took it all very calm like and made every change-over and cue the following day at the office, despite getting only a couple of hours shuteye. **Ross** is secretary-Treasurer of Hollywood Chapter of NABET and in charge of NBC Recording Maintenance . . . it's the **Miller's** first playback . . . The **J. Thomas Baxters**, Blue SE, are also recently blessed-vented . . . a bouncing boy, name of **Richard Whitney Baxter**, six pounds ten ounces 20 inches long AND red hair . . . a Thanksgiving baby, born at 1:40 pm on November 24, at Huntington Hosp. in Pasadena. **Nancy** is doing fine and reports **Tom** spent from 5:30 ayem Friday to 1:30 pm pacing the floor and chain-chewing gum, as he doesn't smoke . . . strain must have been terrific, it being their first commercial. Heartiest congratulations, boys . . .

**VISITORS** . . . Were plentiful this month, what with gone-to-warriors dropping in on holiday furloughs and more dignitaries from the East. . . . **Ben Adler** from Noo Yawk out to see **Denechaud** of the Blue re: new studio installations at Blue Playhouse for KECA . . . **Mr. Adler**, formerly with RCA, is Blue Facilities Engineer and not finding a place to stay, holed up with the **Denechauds** in their mountain retreat in the Hollywood Hills. On same

visit was **Edmund "Jack" Frost** of RCA . . . formerly with **Bill Beltz** in San Fran and L. A. and recently of Camden, **Jack** has just arrived on West Coast to open up offices at 1016 N. Sycamore as Sales Engineer on Engineering Products for RCA Mfg. Co. **Leftenants James Brown** and **Robert Brooke** of the U. S. Navy in for a few minutes each . . . both looking mighty sharp in Navy blue and both maintaining that the Navy is the life, unquote. (If we've said this before, it's just that we're envious . . .) **Lt. Brown** is out here to pick up fambly and take 'em back to Washington . . . both **Jimmy** and **Bob** are associated with Navy Radar work and find it very interestin' . . . tried to sell them an ad in the Journal Yearbook, but they sez that the Navy doesn't need to advertise just at present . . . War Correspondents **Bill Baldwin** and **Clete Roberts** seen in the corridors, too . . . **Bill** is former Blue Special Events man from Frisco and back from Formosa and Saipan, having covered a few Special events over that away. **Clete** is back on leave and resting up after being injured in a Jap bombing on Leyte Island shortly after **MacArthur's** return to the Philippines . . . **Clete** sweated out the long wait for the invason, through a siege of malaria, only to be injured just as it happened . . . is wearing the Purple Heart and some new front crockery, replacing those lost when he bit the dust to avoid the Jap bomb . . . seems he saw that bomb was due to land nearby so took a nosedive for foxhole but forgot to close his chops and lit on his teeth . . . **Frank Figgins**, ex-NBC Maintenance Super, is back and has stopped in several times, and **Louie Onofrio**, ex-NBC SE, was in to scare us all in his Commando suit and heard . . . looked mighty menacing and sez he's connected up with the signal Corps now. **Al Nicolay**, ex-NBC Recording and now Chief Engineer at KTMS, in Santa Barbara, seen at a Western Avenue cafe and reports the rig up there is really "puttin' out" now . . . sez he's got a strong carrier and lots of modulation, good assets for man or broadcast station, we figger . . .

**PARTIES** . . . NBC held their annual Santa Claus reception for the kiddies in Studio "A" just before Xmas and everybody's kids came and had a swell time, with trees and gifts . . . there were also many parties of a private nature at agencies and around, some of which we missed . . . and then there was the Blue's pre-Xmas gathering and social at the Blue Playhouse Friday afternoon, about which we would rather not say much . . . it was a very gay affair, with simply everybody there . . . hosts or rather bartenders were KECA Station Manager **Clyde Scott** and cohorts with vaireee fanceee Hor' durves (never can spell that word . . .) and much moose milk for all . . . loud dancing music was furnished by **Johnny Eilers** and his Rotating Rhythm and that's all we can remember . . . they tell us we had a wonderful time, tho . . . the Blue should have 'em more often, for many beautiful acquaintances were made and interdepartmental relations promoted . . .



Can't remember what happened New Year's at all, altho here it is January so there must have been one . . .

**MOVIES** . . . our star this month is **Robert Jensen**, NABET Chapter Chairman for Hollywood, who is featured in a fifteen-minute short shot by RKO-Pathe for Westinghouse . . . short is story of the Westinghouse program which **Bob** knobs on Sundays . . . pic shows building of program in Studio "D" from script to Master Control, with a bee-you-tiful crane shot of the huge orchestra set-up and rolling in and ending up focused on the **Jensen** mitts on the control dials . . . a special movie version of the control booth and stage was built out at the RKO lot, with even a guy off-stage with a battery gimmick to make the V.I. work yet . . . short was shot on 35 mm and will be reduced to 16 mm for publicity release. Finally caught up with the "Unusual Occupations" movie taken here several months ago and starring **Dottie** and **Leona**, the Sound Effects Kids . . . thing is in Technicolor and the gals look vaireee glamourpuss, in a skit with the Great Gildersleeve and our NBC Chief Announcer **Frank Barton** acting like an announcer. Snapper is shot of Control Booth with **Don Baker**, NBC SE, who was supposed to be the engineer but they have him throwing cues at the actors and sound gals, like a producer yet . . . the Newsreel Theatre where we saw this unusual performance is also now featuring a five-minute newscast during each show, by direct wire from the newsroom at KMTR, a local station . . . a similar deal to the one from KFI to the Pantages, as mentioned here some time ago . . . the idea is catching on locally and is a good one, but they play the announcer's voice so darn loud over the theatre horns that yer teeth rattle and yuh can't chew yer popcorn . . .

**TELEVISION** . . . News lately topped by breaking of ground atop Mt. Wilson for KFI's Television and FM transmitters and antennas . . . Dr. Lee de Forest helped run the bulldozer and KFI chiefs **Harry Blatterman** and **Curtis Mason** arranged special SW broadcasts to mark the event. No actual transmitter construction will start until after the war, probably. **John Swallow**, former NBC Western Division Program Chief and now in charge of Video for Kenyon & Eckhardt in Hollywood and also heading Television Enterprises, back from East with news that television is expected to break right after folding of war in Europe, with satisfactory and inexpensive family reception, according to the latest info, about which he is getting to be an authority . . . M.G.M. Studios have filed with the F.C.C. for a television station too, and the Los Angeles area is destined to be one of the greatest Television centers of the nation, according to **Mr. Swallow** and also to **Mr. John Carmine**, Philco Corp. v.p. out here recently, which is fine and we hope New York won't forget that us fellows out West here are interested in television too . . . **Don Lee** and Paramount stations are still grinding out pictures on regular schedules several nites a week, with no apparant attempts at improvement in production or presentation . . . maybe they don't want to build up the public too much at first, and leave room for improvement later on . . . There is a lot of local interest in the new art, with many movie lots installing Television Departments, several academys, schools, foundations or whatever in town and many agencies assigning men to prepare scripts or shows for prospective clients . . . the general feeling is that it won't

(Continued on Page Thirty)

## TERMINAL

In a single, comprehensive place—  
aptly named **TERMINAL**—you can  
acquire every part, instrument,  
etc., needed in your activities. If  
you can get it anywhere, you can  
get it at

## TERMINAL

**Radio Corporation**  
85 Cortlandt St., New York 7, N.Y.  
Phone: WOrth 2-4415

# HOLLYWOOD

(Continued from  
Page Twenty-Nine)

be long now . . . and let's be ready when the great day comes . . .

BLUE . . . Chief Denechaud back from jaunt East to Washington to some bureau or other, and while back there visited FM and Television installations and saw all the latest gadgets at RCA and GE . . . climbed some mountains to visit transmitters in the snow and reports that this new receiver with the plastic lens and indirect viewing is really FB . . . Helen, our lovely red-haired Miss Blue, is glad to see him back, to take over paper work and tell people things on the telephones . . . during Denny's absence, our man Ragsdale, Blue SE/FE, has been keeping things under control and acting as assistant chief, when not out on Coke shows . . . Rags had quite a time Xmas Day with Coca-Cola over in Clovis, New Mexico, when due to erratic transportation he was the only one of the production crew to arrive there . . . the ork just barely made it in time for the broadcast and Rags had to be combo engineer and producer, standing up during show and throwing cues, timing script and twirling knobs all at once . . . what a way to spend Xmas, sez Rags. Lorenz busy with the Hall of Fame pickups from Earl Carrolls . . . has "Pops" White-man ork and big doins, and manages to need nearly every bit of gear in the place . . . the booth is simply a maze of connections. Carl sez he is looking for a small outboard motor now (not for the show, altho it wouldn't surprise us . . .) and if anybody has one for sale, please let him know . . . guess we will have to set up Lorenz's Trading Post and Swap Shop . . . Stuff Traded for Any-

thing, or What Have You? LaCroix dee-vising a new microphone pick-up technique for orchestra . . . you simply get some tin cans and stretch strings from holes in the bottom and tie all the strings to a common point and adjust the various tensions until you get a balance . . . wonder how Thor's balance is . . . bet the thing wouldn't be practical anyway, because common points are too scarce . . . priorities, you know. McGaughey, SE, reported suffering from arthritis last month now has the gout it turns out . . . his doc put him on a strict diet, with no meat, onions or stimulating beverages, etc., and what's the use of living, sez Bob . . . apparantly you have, old man . . .

## Aaron Lippman & Co.

246 Central Avenue Newark, N. J.

### Radio and Electronic Equipment

*We Expedite — Ask Anyone*

#### Courmettes & Gaul OPTICIANS

55 West 49th Street  
R. C. A. Building (Main Floor), New York

EYE EXAMINATIONS

Prescriptions Filled . . . Prompt Repair Work

Invisible Contact Lenses Fitted



STATION **W6XYZ** HOLLYWOOD  
CHANNEL 4 7B-84 TV



THE TELEVISION WINDOW  
ENLARGES YOUR HORIZON

---

**WEDNESDAY, AUGUST 30, 1944**

<p>8:00 P.M. TEST PATTERN - RECORDED MUSIC</p> <p>8:30 P.M. BOXING WITH JUNIOR by JIM DAVIES</p> <p>8:45 P.M. "GOOFY ADVENTURES" - Part 4 a TELE-TOON strip by FRANK WEBB</p>	<p>9:00 P.M. CHILDREN'S VARIETY SHOW Aspirants to Stardom</p> <p>9:15 P.M. MOVIE-TOWN BACKSTAGE with PARAMOUNT PLAYERS</p>
---	--

---

**FRIDAY, SEPTEMBER 1, 1944**

<p>8:00 P.M. TEST PATTERN - RECORDED MUSIC</p> <p>8:30 P.M. THE WAR PICTURE THIS WEEK by T. B. BLACKISTON</p> <p>8:50 P.M. CARTOON OF THE WEEK the Funny Side of the News</p>	<p>9:00 P.M. VISIT TO SYRIA AND IRAQ a TELE-TRAVEL feature Narrated by GEORGE BRANDT</p> <p>9:15 P.M. EMBARRASSING SITUATIONS A COMEDY SERIAL with DIDI CODRE, CHARLES QUIGLEY, STAN JOHNSON and EVA PUIG</p>
---	---

YOUR OBSERVATIONS  
ON THE RECEPTION OF  
THESE EXPERIMENTAL  
TRANSMISSIONS WILL  
AID US TO IMPROVE  
THIS SERVICE.

## TELEVISION PROGRAM

SUBJECT TO CHANGE WITHOUT NOTICE



but that's life in Hollywood for you . . . (the lad is only 22 or 3) . . . a short one but a merry one. Hal Powell back from Reno with the "Breakfast at Sardis" gang . . . reports there they stamp the date on each pack of ciggies and ration you one per day or week or whatever and you have to turn in the old one to get a new one . . . Hal spent considerable time picking them up and laying them down, on the odd and the red . . . sez it gets you in the end . . . where you keep your pocketbook. "They'll Do It Every Time" Dep't. . . as we have reported several issues ago, the Blue is building some new studios for KECA in the Blue Playhouse building up Sunset Boulevard, a few blocks from Radio City . . . Well, things are coming along fine and rooms are in the painting stage, when one of the contractors or somebody discovers that there is some nice paint left over and how would it be to brighten things up a little in the auditorium studio . . . so they move upstairs with the spray guns and proceed to spray everything a nice, delicate light gray . . . the studio walls are paneled



with Celotex softboard, punched full of tiny holes to soak up the acoustics, only there aren't any holes any more and now the softboard feels like cement . . . when Denny came back from trip East and examined the results, he said (censored) . . . and now they are trying to locate the guy who did it . . . teehee . . . he brightened it up alright . . . Blue Engineering office in receipt of two interesting letters from a couple of overseas Blue engineers . . . **Jim Cunningham** is over in England as a technical observer with the rank of captain and gradually getting used to warm beer, and **Lt. Roger Love** of the Signal Corps writes from India that the place is quite a place, where cows get more attention than humans . . . wish space permitted quoting more, but both say they will be glad to get back to Hollywood.

**AROUND THE BUILDING** . . . Well, they have finally moved the Field Shop and the boys are out of solitary and right up on the main floor, across the corridor from Engineering Maintenance . . . space was formerly the prop room and then some of it was wacked off to form transcription booths or Studios "L" and "M" and later the props and sound effects gear were moved down the hall to the new Annex and the remaining space given over to **Hymuller** for his piano department. Now about a fourth of **Hymuller's** domain has been stolen for a Field Shop, making one approximately the same size as the old one, but infinitely more convenient, as **Hal Platt** and Field Super **Joe Kay** will testify . . . all small gear, work benches and amplifiers will be kept in the new spot, with larger items such as speakers, mike stands and mike boxes stored in the Annex with the portable booths. This will make a nice arrangement, for all gear can now be loaded directly on the trucks and mobile units without going up and down elevators, etc. Also the boys will get to see somebody once in awhile, altho we can anticipate some QRM and possibly QRN when **Hymuller** gets to tuning his G string and **Hal** is tuning up some SW gear or testing a speaker . . . bet **Hal** wins, however, 'cause he can make his louder. Across the hall **Johnny Morris** and his Reproducing Group have just about finished the second Super-Jeep . . . it's a re-recording truck on wheels, complete with three turntables, combination pickups, speakers, V.I.'s, etc. . . . in fact everything but floating power . . . **Johnny** even thot of that, but was talked out of it . . . had some deal figured out where the thing was propelled by storage batteries, kept charged by small generators hooked on the turntable shafts, with a horn and lights for night driving, but the front office put the nix on it. Favorite gag among studio men is to catch some recording engineer operating the contraption and ask him is he vertical or lateral . . . answer is invariably lateral. "This Really Happened" Dep't . . . **Howard Cooley**, recording, and one of our more pre-occupied fellows, was walking down the corridor the other day carefully carrying a 16-inch glass base pre-dub record in front of him in both hands and some wag tip-toes up behind him and sez, "drop it!" so **Howie** does . . . strictly a reactionary kid . . .

**QUICKIES** . . . **Jake O'Kelly** back after a tough siege in hosp. and at home resting up from his operation . . . glad to see **Jake** with us again, 'cause he always has an entertaining story for the loung-ites. **Lew Winkler** and **Oscar Wick**, ME's, taking courses in heavy math at USC . . . from a lady teacher . . . boys say she knows lots of

(Continued on Page Thirty-Two)

## CAPPS\*

SAPPHIRE is, and has always been, the only material for making cutting styli for high class recordings.

CAPPS\* Patented Sapphire Styli (2187512) are the original and accepted standard for high class professional acetate recordings.

*Imitated but not equalled*

**FRANK L. CAPPS & CO.**

244 W. 49th STREET NEW YORK CITY

Telephone Circle 6-5285

\* Reg. U. S. Pat. Off.

## C O P I E S

**BY DIRECT CUTTING  
OF YOUR RECORDINGS**

33 $\frac{1}{3}$  RPM transcriptions  
for broadcast or audition  
use.

**24 HOUR SERVICE**  
—packaged and shipped  
from Chicago.

Aluminum based material  
available for broadcast use.

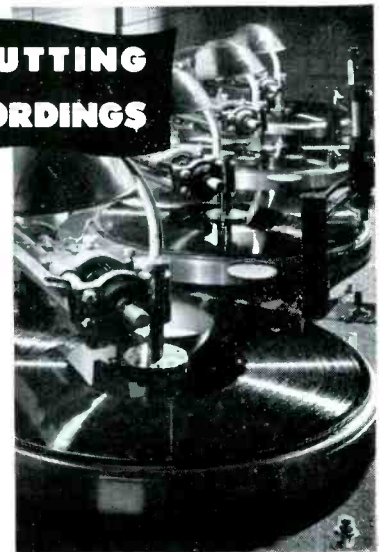

*Write for  
complete  
details and  
prices.*

**L. S. TOOGOOD**  
**RECORDING COMPANY**  
221 N. LA SALLE ST. CHICAGO 1

# Chicago Chapter Chatter . . . By Arthur Hjorth

**H**ONEY-BOY" Martin's bees are roosting in his chicken coop this winter.

"Uncle Ezra" Cabasin has his own retirement plan to become effective at 65, or sooner, if required. Aspires to open a shop cluttered with tools, a cracker barrel and a checkerboard. Sign tacked to the outer door would read, "Mr. Fixit—If I can't fixit, throw it away." Caution: Do not take more than \$15 in cash per month or you won't get your Social Security money back.

Numismatist Glenn Webster (VP?), had his interest renewed when a tired old Prussian penny proved to be a gold piece, sold for five bucks cash.

Trumpet-tooter Kermit Slobb, also Blue engineer, now has his card and is available for night club engagements.

Jim Platz asked Ellen to have piano tuner set "A" to WWV's 440 tone so he could accompany John Charles Thomas on Sunday afternoons (unknown to Charlie). String-buster told Mrs. Platz that these here new-fangled radio signals weren't reliable. Later Jim found that the "A" was within a beat of WWV.

Disposition of his snake collection made it possible for "Chuck" Corliss to purchase and find room for a Cable spinet piano.

Al Otto's son, Joe, in the Navy, is stationed near Oklahoma City incorporating his papa's ideas in Navy Radar. Al himself has the gout from many weary weeks of stooping on the damp basement floor assembling a railroad for son Paul's Xmas. Rella also had him paint the walls and floor while he was down there.

Pete Cavanah has nothing to report. While we are on the subject, Mary Trotter and Harry Maule are still single.

Art Elkins reported convalescent from siege in the hospital. Art sez, "Any assumption that the closing of the racetracks cause a relapse is purely coincidental." Amen sez RSD, MJW and WCL . . . added echo from JRM.



Out-of-focus Hjorth photo starring Producer George Maher "throwing a cue" to the Chicago Council.

Welcome mat to P. K. Franklin, formerly chief at Purdue's WBAA. Also to Norman H. Kindlund.

H. G. Newbauer lost some hide from his glamorous "pins" the other nite, sliding down the ladder from his office to the power room when Pinkerton, "We always keep one eye closed" hollered, "C-O-F-F-E-E".

Both WENR-WLS and WMAQ transmitters reported on the air by listeners writing to the Merchandise Mart. From this indirect correspondence we can safely assume that the staffs at these radio stations are well, happy, contented and prolific.

December council meeting was also farewell party for George Maher, charter ATE member and active, progressive leader in Chicago NABET. Known from coast to coast, he departed for more fertilized pastures as producer for Schwimmer & Scott and associated with Alan Fishburn. George started at Frisco in '33 after some time in the Navy and came to Chicago in '36. Without men like George Maher NABET would have died of "dry-rot" years ago. Everyone hated to see him leave.

## HOLLYWOOD

(Continued from Page Thirty-One)

angles. Kenny Hicks, MCD, doing sums on adding machine to save time . . . and getting the pre-sets wrong on the dad-blamed thing, with some sums coming out . . . probably forgot to drop and re-select. Kenny was looking at some post-cards of a foreign nature the other day and blushing a beautiful cerise. Horse racing off again at California tracks and Mexico too darn far away for our coupon book . . . Albert "Cappy" Capstaff, former NBC SE and now a big agency man, going in for real estate on the side . . . understand has purchased a whole building a few blocks from Radio City . . . back of the Hollywood Camera Exchange. "Denny" Denechaud, Blue engineering head, just elected Secretary of Los Angeles Section of I.R.E. . . . when interviewed, sez our gal Helen really the one elected . . . to do the paper work, etc. . . . heh . . . Attention, Bro. Anderson, N. Y. re: MTCE's . . . thanx, but we were right too, huh? Maybe we can rate four-letter titles out here someday . . . it's something to look forward to, huh fellows? Al Korb's lovely daughter Shirley, a liberty belle . . . belongs to a group of Burbank 'teeners who assist in Red Cross and other community war activities . . . Ray Provost, new Recording Engineer . . . from KPAS in Pasadena and also formerly of KGB in San Diego . . . just got here and passed his physical for 1-A, so this may be hail and farewell . . . Tropics joint across the street just re-decorated and bar enlarged . . . interior now very pleasing, all except rather ghastly blue ceiling . . . needs some clouds or something . . . received some nice news notes from Joe Dessert of KECA transmitter and will pass them along next issue, together with the motorcycle stories, which are getting bigger and better. Time for a goodie, tho . . . it seems Tom Breneman, the man on "Breakfast at Sardie" was walking down the Boulevard one morning on his way to the restaurant and before leaving home had just taken a purgative and along comes a car and just as it gets opposite Tom, a tire blows out . . . BCNU.





*History of Communications. Number Thirteen of a Series*

## MILITARY RADIO COMMUNICATIONS

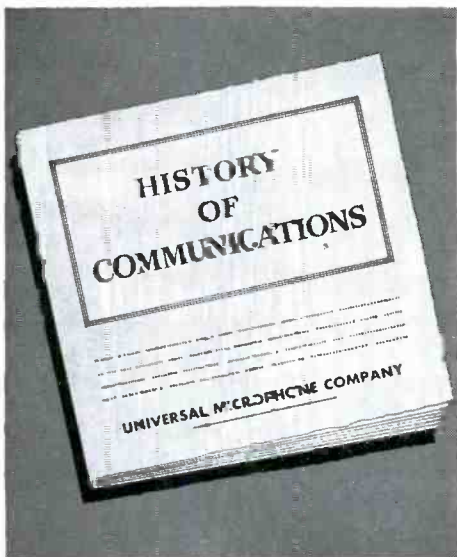

Today the allied military radio equipments represent the "tops" in engineering design. Progress from the spark transmitter of World War I to present-day equipment is, indeed, a far cry. Taking up where they left off December 7, 1941, Universal Engineers, with their added experience with precision military equipment, shall produce for the public, electronic devices not of fantastic design — but of proven utility and quality.

After Victory is ours, radio amateurs, affectionately known as "hams," will be back after their experience with military radio equipment with an even greater desire to operate their own "rigs." It will be then that Universal will again have Microphones and recording components available on dealers' shelves.

< *FREE—History of Communications Picture Portfolio. Contains over a dozen pictures suitable for office, den, or hobby room. Write for your "Portfolio" today.*



**UNIVERSAL MICROPHONE COMPANY**  
INGLEWOOD, CALIFORNIA



FOREIGN DIVISION: 301 CLAY STREET, SAN FRANCISCO 11, CALIFORNIA • CANADIAN DIVISION: 560 KING STREET WEST, TORONTO 1, ONTARIO, CANADA



# DAVEN

## ATTENUATION NETWORKS

### Series 690

DAVEN Series 690 Attenuation Networks comprise 20 models, designed for general laboratory and production testing at audio frequency levels. DAVEN plug-in type Fixed Attenuators are employed for matching source and load impedances with the base impedance of the network. A high degree of flexibility is thus achieved with an absence of mis-match, reflection loss and switching noises.

#### MODEL VARIATIONS

- 2 MOUNTINGS: Portable and Rack Type
- 3 BASE IMPEDANCES: 500, 600 and 135 ohms
- 2 CIRCUITS: "T" and Balanced "H"
- 2 RANGES: 0-110DB steps of 1DB (2 dials)  
0-111DB steps of 0.1DB (3 dials)

\*Balanced "H" type may be used as an unbalanced network of one-half the base impedance.



#### OTHER SPECIFICATIONS

**ACCURACY:** Resistors calibrated within  $\pm 1\%$

**PLUG-IN PADS:** Octal tube base, panel mounting, in wide range of impedances and losses.

**FREQUENCY RANGE:** 0-17,000 c.p.s.; at higher frequencies, slight reduction in accuracy.

**OPERATION LEVEL:** +20DB (0.6w) maximum input.

**SIZE:** 2 dial portable: 5"x10"x5"; 3 dial portable: 6"x11 1/2"x5"; rack: 3 1/2"x19".

Daven Attenuation Standards, types 740 and 742 (resistor accuracy  $\pm 1/2\%$ ), are designed for applications requiring greater accuracy. See your DAVEN Catalog or write for details.

#### PORTABLE TYPES

"T"	BAL "H"	DB RANGE	BASE Z
T 690-A	H-690-B	0-110	500
T 690-C	H-690-D	0-110	600
T 692	H-692	0-111	500
T 693	H-693	0-111	600
T 694	H-694	0-111	135

#### RACK TYPES

"T"	BAL "H"	DB RANGE	BASE Z
T-690-AR	H-690-BR	0-110	500
T-690-CR	H-690-DR	0-110	600
T-692-R	H-692-R	0-111	500
T-693-R	H-693-R	0-111	600
T-694-R	H-694-R	0-111	135



THE **DAVEN** COMPANY  
191 CENTRAL AVENUE  
NEWARK 4, NEW JERSEY

YOU CAN MAKE NO GREATER PERSONAL CONTRIBUTION TO THE WAR EFFORT THAN TO DONATE A PINT OF YOUR BLOOD TO THE RED CROSS